

chill index

100 Year Celebration : August 2020

Retail Prices (Ex GST)

 **orford**
REFRIGERATION

1920 - 2020 - 100 Years Young

www.orford.com.au

Orford Chill Index

Refrigerators—General

Orford FMB20	Page 5
Orford FMB Black	Page 6
Orford FMB30	Page 7
Orford EB20 EcoChill™ Range	Page 8
Orford EB30 EcoChill™ Range	Page 10
Orford EB30 Storage Fridge	Page 11
Orford EB36 EcoChill™ Range	Page 13
Orford EB36 Pass Thru Rear Loading	Page 14
Orford EB45 EcoChill™ Range	Page 15
Orford EB45 Pass Thru Rear Loading	Page 16
Orford EB EcoChill™ Energy Figures	Page 17
Halo HR350-B Slim Impulse	Page 18
Halo TF85 Impulse counter top	Page 19

Freezer— General

Orford VB36L Freezer	Page 22
Orford FML Freezer Series	Page 23
Halo Freezer Range	Page 27

Refrigerator—Specialties

Orford Flower Fridges 4U	Page 29
Orford Wine Fridges	Page 33
Orford Chocolate Fridges	Page 38
Orford Cake Fridges/Freezers	Page 41

Freezer—Specialties

Orford VB36 IM Ice Merchandiser	Page 46
---------------------------------	-------------------------

Underbench / Underbars

Orford BB Backbar Range	Page 51
Halo KUR Undercounter Refrigerator	Page 54
Halo KUF Undercounter Freezer	Page 56
Halo KURF Undercounter Combos	Page 57



chill index

www.orford.com.au

www.halorefrigeration.com.au

1300 ORFORD

1300 673 673

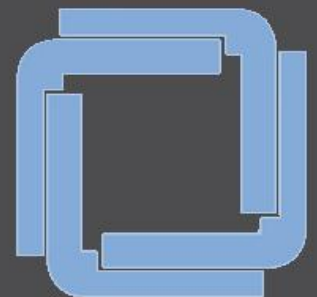

Orford Chill Index

Halo Food Services

- Halo KRF Fridge/Freezer [Page 61](#)
- Halo KR Refrigerator [Page 65](#)
- Halo KF Freezer [Page 66](#)
- Halo KF Glass Freezer [Page 67](#)
- Halo 20 Milk Dispenser [Page 68](#)
- Halo KHR Salad Table [Page 69](#)

Manitowoc Ice Machines

- Manitowoc UG Series
- Manitowoc Neo U Series
- Manitowoc Indigo Series
- Manitowoc Flakers
- Manitowoc Nugget Machines
- Manitowoc M Series
- Manitowoc Accessories
- Manitowoc Commercial Warranty

Orford Finance

[Page 89](#)

Orford Sign Shop

Terms & Conditions

MEPS / Cabinets & Climate Class

Contact Us

Prices are excluding GST, Freight and Insurance

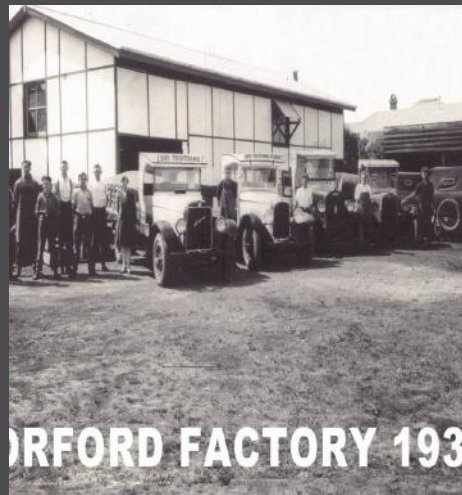

chill index

www.orford.com.au

www.halorefrigeration.com.au

1300 ORFORD

1300 673 673

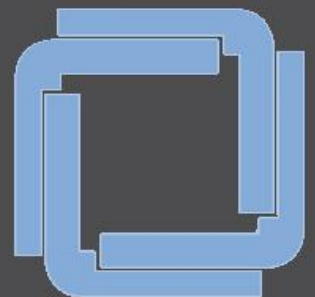

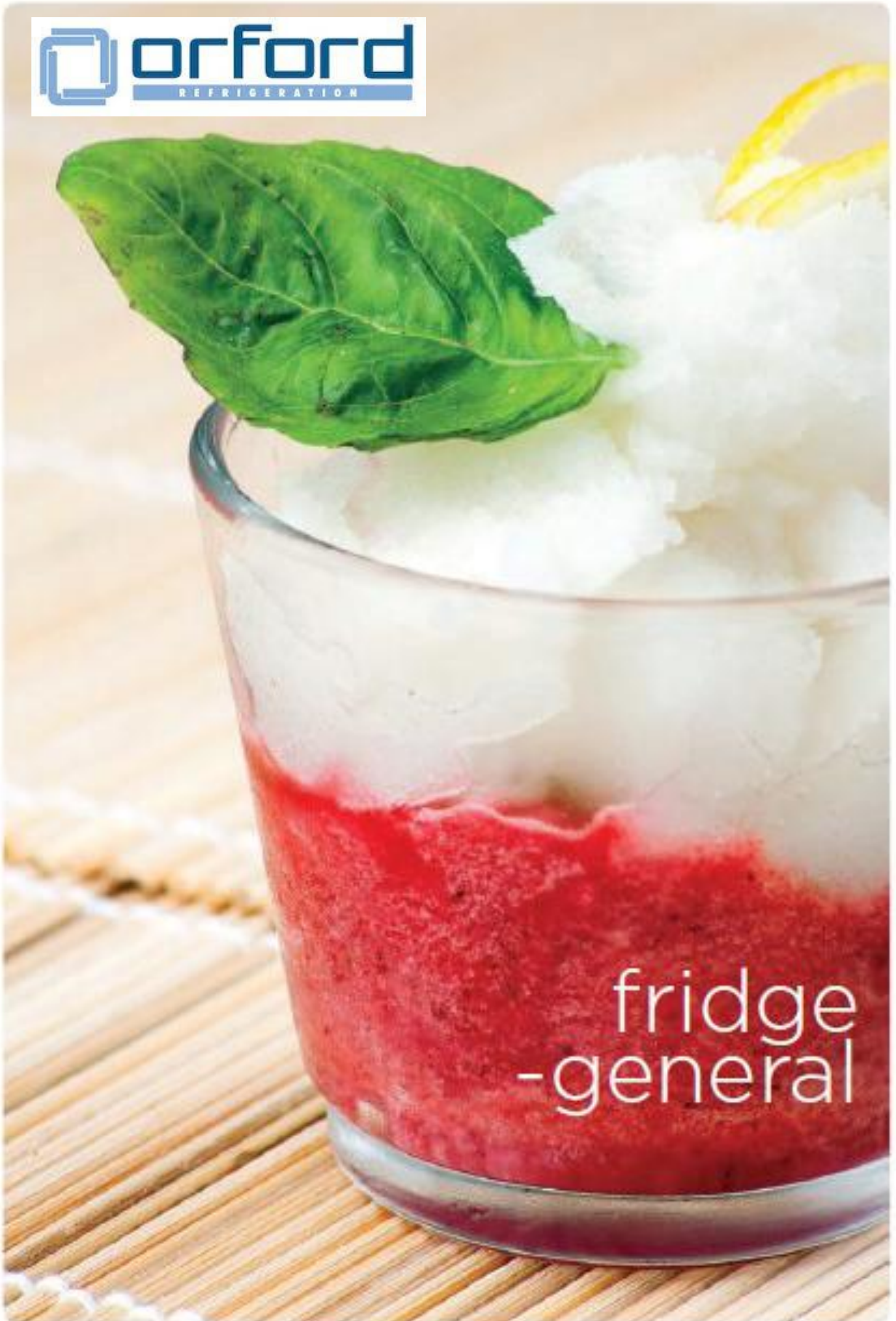

fridge
-general

Do you have an ABN?
Contact us for a trade discount!

FMB20—B	Vertical Display Refrigerator
Capacity	557 Litres (Gross)
Dimensions	740W x 791D x 2010H
Weight	165Kg
Operating Temp	0° - 5° C.
Ambient Temp	0° - 40° C.
Range	
Power Point	230 - 240v 50Hz. (Standard GPO)
Controller	Digital—Carel controller
Shelves	4 Height Adjustable Heavy Duty PVC Coated
Shelf Adjustment	12mm Increments
Door	1 x Self Closing, Double Glazed Safety Glass, Single Heat reflective Low E, Argon filled, Right Hand hinged. (Left hand hinge available)
Footings	Heavy Duty Castors, Lockable Front
Compressor	Danfoss
Interior Light	LED (on/off switch included)
Refrigerant	R134A
Insulation	50mm Polyurethane, CFC, HCFC, HFC Free
Climate Class	Class 5
MEPS	Compliant (High Efficiency)
Condenser Filter	Rear mounted

FMB20-Sn	Vertical Display Refrigerator with Illuminated Advertising Sign
Construction	Powder Coated galvanized steel Int / Ext White
Capacity	557Litres (Gross)
Dimensions	740W x 791D x 2200H
Weight	165Kg
Operating Temp	0° - 5° C.
Ambient Temp	0° - 40° C.
Range	
Power Point	230 - 240v 50Hz. (Standard GPO)
Controller	Digital Carel Controller
Shelves	4 Height Adjustable Heavy Duty PVC Coated
Shelf Adjustment	12mm Increments
Door	1 x Self Closing, Double Glazed Safety Glass, Single Heat reflective Low E, Argon filled, Right Hand hinged.
Footings	Heavy Duty Castors, Lockable Front
Compressor	Danfoss
Interior Light	LED (on/off switch included)
Refrigerant	R134A
Insulation	50mm Polyurethane, CFC, HCFC, HFC Free
Climate Class	Class 5
MEPS	Compliant (High Efficiency)
Condenser Filter	Rear mounted
Illuminated Advertising Sign	200mm High, Top Mounted.
Sign Illumination	LED

Orford FMB20—B

RRP : \$2600 + GST



Energy consumed : 5.425 kWh/24hr

Orford FMB20Sn—B

RRP : \$2745 + GST



Energy consumed : 5.589 kWh/24hr

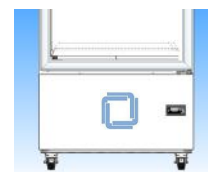

New with Carel digital controller

Do you have an ABN?
Contact us for a trade discount!

FMB20-Sn-B	Vertical Display Refrigerator with Illuminated Advertising Sign
Construction	Powder Coated galvanized steel Int / Ext Black
Capacity	557Litres (Gross)
Dimensions	740W x 791D x 2200H
Weight	165Kg
Operating Temp	0° - 5° C.
Ambient Temp Range	0° - 40° C.
Power Point	230 - 240v 50Hz. (Standard GPO)
Digital Controller	Digital Carel Controller
Shelves	4 Height Adjustable Heavy Duty PVC Coated
Shelf Adjustment	12mm Increments
Door	1 x Self Closing, Double Glazed Safety Glass, Argon filled Single Heat reflective Low E, Right Hand hinged.
Footings	Heavy Duty Castors, Lockable Front
Compressor	Danfoss
Interior Light	LED (on/off switch included)
Refrigerant	R134A
Insulation	50mm Polyurethane, CFC, HCFC, HFC Free
Climate Class	Class 5
MEPS	Compliant (High Efficiency)
Condenser Filter	Rear mounted
Illuminated Advertising Sign	200mm High, Top Mounted.
Sign Illumination	LED

Orford FMB20Sn-B—Black
RRP : \$2745 + GST



Energy consumed : 5.425

FMB30-Sn	Vertical Display Refrigerator with Illuminated Advertising Sign
Construction	Powder Coated galvanized steel Int/ Ext Black
Capacity	889 Litres (Gross)
Dimensions	1130W x 791D x 2200H
Weight	210Kg
Operating Temp	0° - 5° C.
Ambient Temp Range	0° - 40° C.
Power Point	230 - 240v 50Hz. (Standard GPO)
Digital Controller	Digital Carel Controller
Shelves	8 Height Adjustable Heavy Duty PVC Coated
Shelf Adjustment	12mm Increments
Door	1 x Self Closing, Double Glazed Safety Glass, Argon filled Single Heat reflective Low E, Right Hand hinged.
Footings	Heavy Duty Castors, Lockable Front
Compressor	Danfoss
Interior Light	LED (on/off switch included)
Refrigerant	R134A
Insulation	50mm Polyurethane, CFC, HCFC, HFC Free
Climate Class	Class 5
MEPS	Compliant (High Efficiency)
Condenser Filter	Rear mounted
Illuminated Advertising Sign	200mm High, Top Mounted.
Sign Illumination	LED

Orford FMB30Sn-B-Black
RRP : \$3408 + GST



Energy consumed : 5.589 kWh/24hr



New with Carel digital controller

Do you have an ABN?
Contact us for a trade discount!

FMB30—B	Vertical Display Refrigerator
Construction	Powder Coated galvanized steel Interior / Exterior White
Capacity	889 Litres (Gross)
Dimensions	1130W x 791D x 2010H
Weight	210Kg
Operating Temp	0° - 5° C.
Ambient Temp Range	0° - 40° C.
Power Point	230 - 240v 50Hz. (Standard GPO)
Controller	Digital Carel Controller
Shelves	8 Height Adjustable Heavy Duty PVC Coated
Shelf Adjustment	12mm Increments
Door	1 x Self Closing, Double Glazed Safety Glass, Single Heat reflective Low E, Argon filled, Right Hand hinged.
Footings	Heavy Duty Castors, Lockable Front
Compressor	Danfoss
Interior Light	LED (on/off switch included)
Refrigerant	R134A
Insulation	50mm Polyurethane, CFC, HCFC, HFC Free
Climate Class	Class 5
MEPS	Compliant (High Efficiency)
Condenser Filter	Rear mounted

FMB30-Sn—B	Vertical Display Refrigerator with Illuminated Advertising Sign
Construction	Powder Coated galvanized steel Int/ Ext White
Capacity	889 Litres (Gross)
Dimensions	1130W x 791D x 2200H
Weight	210Kg
Operating Temp	0° - 5° C.
Ambient Temp Range	0° - 40° C.
Power Point	230 - 240v 50Hz. (Standard GPO)
Controller	Digital Carel Controller
Shelves	8 Height Adjustable Heavy Duty PVC Coated
Shelf Adjustment	12mm Increments
Door	1 x Self Closing, Double Glazed Safety Glass, Single Heat reflective Low E, Argon filled, Right Hand hinged.
Footings	Heavy Duty Castors, Lockable Front
Compressor	Danfoss
Interior Light	LED (on/off switch included)
Refrigerant	R134A
Insulation	50mm Polyurethane, CFC, HCFC, HFC Free
Climate Class	Class 5
MEPS	Compliant (High Efficiency)
Condenser Filter	Rear mounted
Illuminated Advertising Sign	200mm High, Top Mounted.
Sign	LED
Sign Illumination	LED

Orford FMB30—B

RRP : \$3265 + GST



Energy consumed : 7.59 kWh/24hr

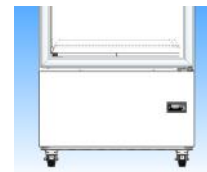

New with Carel digital controller

Orford FMB30Sn—B

RRP : \$3408 + GST



Energy consumed : 8 kWh/24hr



Do you have an ABN?
Contact us for a trade discount!

EB20R-Sn Specifications	Vertical Display Refrigerator with Illuminated Advertising Sign
Construction	Powder Coated galvanized steel Interior / Exterior White
Capacity	595 Litres (Gross)
Dimensions	756W x 762D x 2220H
Weight	155Kg
Operating Temp	0° - 5° C.
Ambient Temp Range	0° - 40° C.
Power Point	220 - 240v 50Hz. (Standard GPO)
Input Current	2.8 Amps
Thermometer	Digital
Shelves	4 Height Adjustable Heavy Duty PVC Coated
Shelves	1 Fixed Stainless Steel Base Shelves
Shelf Adjustment	12mm Increments
Refrigerated Shelf Area	1.42 m ²
Condensate Disposal	Automatic by energy efficient, No Cost, Hot Gas
Door	1 x Self Closing, Double Glazed Safety Glass, Double Heat reflective Low E, Warm edge, R/H
Footings	Heavy Duty Castors, Lockable Front
Interior Light	LED, Automatic and manual control
Refrigerant	R134a
Drier	Solid Core
Insulation	50mm Polyurethane, CFC, HCFC, HFC Free
Cabinet Classes	3M1, 4M1, 5M1
MEPS	Compliant (High Efficiency)
* Energy Consumption	3.43 kWh/24h
Condenser Filter	Easy front access
Illuminated Advertising Sign	200mm High, Top Mounted
Sign Illumination	LED, Automatic and manual control

RRP : \$3800 + GST
Orford EB20R-Sn-A

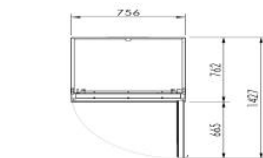

IP Protected by AUS DSN no 345317
& Patent NO 2013100761

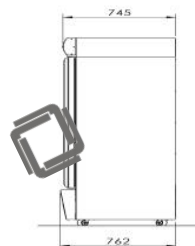
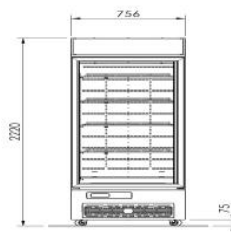

The Orford Group EB Model	Energy Consumption @3M1 kWh/24hr
EB20R-A	3.17
EB20R-SN-A with illuminated sign	3.43



Do you have an ABN?
Contact us for a trade discount!

EB20R-BLO-A Specifications	Vertical Storage Refrigerator
Construction	Stainless Steel
Capacity	595 Litres (Gross)
Dimensions	756W x 762D x 2220H
Weight	165Kg
Operating Temp	0° - 5° C.
Ambient Temp Range	0° - 40° C.
Power Point	220 - 240v 50Hz. (Standard GPO)
Input Current	2.8 Amps
Thermometer	Digital
Shelves	4 Height Adjustable Heavy Duty PVC Coated
Shelves	1 Fixed Stainless Steel Base Shelves
Shelf Adjustment	12mm Increments
Refrigerated Shelf Area	1.42 m ²
Condensate Disposal	Automatic by energy efficient, No Cost, Hot Gas
Door	1 x Self Closing, Block doors
Footings	Heavy Duty Castors, Lockable Front
Interior Light	LED, Automatic and manual control
Refrigerant	R134a
Cabinet Classes	3M1, 4M1, 5M1
MEPS	Compliant (High Efficiency)
* Energy Consumption	3.43 kWh/24h
Condenser Filter	Easy front access
Sign Illumination	LED, Automatic and manual control

RRP : \$4415 + GST
Orford EB20R-Blo-A



IP Protected by AUS DSN no
345317 & Patent

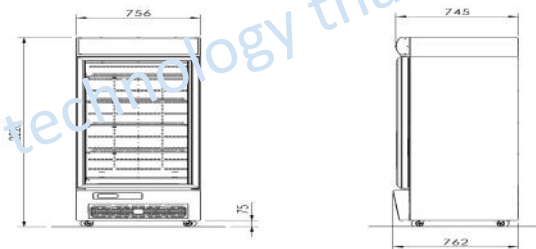

The Orford Group EB Model	Energy Consumption @3M1 kWh/24hr
EB20R-BLO-A	3.17

technology that works



Do you have an ABN?
Contact us for a trade discount!

EB30R-Sn Specifications	Vertical Display Refrigerator with Illuminated Advertising Sign
Construction	Powder Coated galvanized steel Interior /Exterior White
Capacity	895 Litres (Gross)
Dimensions	1094W x 762D x 2220H
Weight	210Kg
Operating Temp	0° - 5° C.
Ambient Temp Range	0° - 40° C.
Power Point	220 - 240v 50Hz. (Standard GPO)
Input Current	2.8 Amps
Thermometer	Digital
Shelves	8 Height Adjustable Heavy Duty PVC Coated
Shelves	2 Fixed Stainless Steel Base Shelves
Shelf Adjustment	12mm Increments
Refrigerated Shelf Area	2.17 m ²
Condensate Disposal	Automatic by energy efficient, No Cost, Hot Gas
Door	2 x Self Closing, Double Glazed Safety Glass, Double Heat reflective Low E, Warm edge
Footings	Heavy Duty Castors, Lockable Front
Interior Light	LED, Automatic and manual control
Refrigerant	R134a
Cabinet Classes	3M1, 4M1, 5M1
MEPS	Compliant (High Efficiency)
* Energy Consumption	4.24 kWh/24h
Condenser Filter	Easy front access
Illuminated Advertising Sign	200mm High, Top Mounted
Sign Illumination	LED, Automatic and manual control

RRP : \$4324 + GST
Orford EB30R-Sn-A

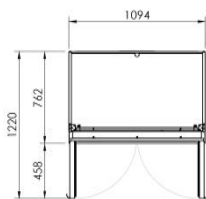

IP Protected by AUS DSN no 345317
& Patent NO 2013100761

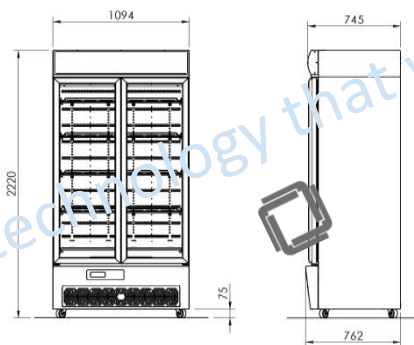

The Orford Group EB Model	Energy Consumption @3M1 kWh/24hr
EB30R-A	3.78
EB30R-SN-A with illuminated sign	4.24

technology that works



Do you have an ABN?
Contact us for a trade discount!

EB30R-BLO-A Specifications	Vertical Storage Refrigerator
Construction	Stainless Steel
Capacity	895 Litres (Gross)
Dimensions	1094W x 762D x 2220H
Weight	210Kg
Operating Temp	0° - 5° C.
Ambient Temp Range	0° - 40° C.
Power Point	220 - 240v 50Hz. (Standard GPO)
Input Current	2.8 Amps
Thermometer	Digital
Shelves	8 Height Adjustable Heavy Duty PVC Coated
Shelves	2 Fixed Stainless Steel Base Shelves
Shelf Adjustment	12mm Increments
Refrigerated Shelf Area	2.17 m ²
Condensate Disposal	Automatic by energy efficient, No Cost, Hot Gas
Door	2 x Self Closing, Block doors
Footings	Heavy Duty Castors, Lockable Front
Interior Light	LED, Automatic and manual control
Refrigerant	R134a
Cabinet Classes	3M1, 4M1, 5M1
MEPS	Compliant (High Efficiency)
* Energy Consumption	4.24 kWh/24h
Condenser Filter	Easy front access
Illuminated Advertising Sign	200mm High, Top Mounted
Sign Illumination	LED, Automatic and manual control

RRP : \$4800 + GST
Orford EB30R-Blo-A

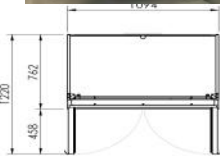

IP Protected by AUS DSN no
345317 & Patent

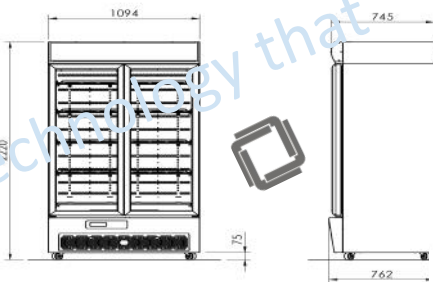

The Orford Group EB Model	Energy Consumption @3M1 kWh/24hr
EB30R-BLO-A	3.78



Do you have an ABN?
Contact us for a trade discount!

EB30R-Sn-PT Specifications	Rear Loading Display Refrigerator with Illuminated Advertising Sign
Construction	Powder Coated galvanized steel Interior /Exterior White
Capacity	895 Litres (Gross)
Dimensions	1094W x 762D x 2220H
Weight	210Kg
Operating Temp	0° - 5° C.
Ambient Temp Range	0° - 40° C.
Power Point	220 - 240v 50Hz. (Standard GPO)
Input Current	2.8 Amps
Thermometer	Digital
Shelves	8 Height Adjustable Heavy Duty PVC Coated
Shelves	2 Fixed Stainless Steel Base Shelves
Shelf Adjustment	12mm Increments
Door + Rear doors	2 x Self Closing, Double Glazed Safety Glass, Double Heat reflective Low E, Warm edge
Footings	2 x Self closing powdercoated doors Heavy Duty Castors, Lockable Front
Interior Light	LED, Automatic and manual control
Refrigerant	R134a
Drier	Solid Core
Insulation	50mm Polyurethane, CFC, HCFC, HFC Free
Cabinet Classes	3M1, 4M1, 5M1
MEPS	Compliant (High Efficiency)
* Energy Consumption	4.74 kWh/24h
Condenser Filter	Easy front access
Illuminated Advertising Sign	200mm High, Top Mounted
Sign Illumination	LED, Automatic and manual control

RRP : \$4622 + GST
Orford EB30R-Sn-A-PT

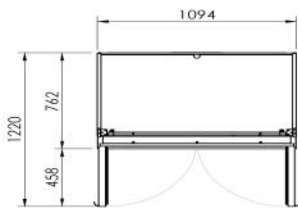

IP Protected by AUS DSN no 345317
& Patent NO 2013100761

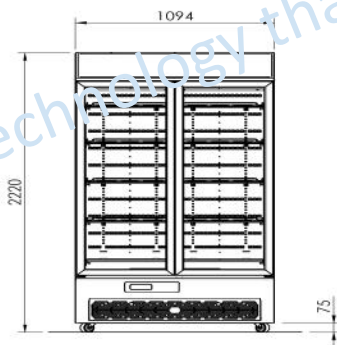

Do you have an ABN?
Contact us for a trade discount!

EB36R-Sn Specifications	Vertical Display Refrigerator with Illuminated Advertising Sign
Construction	Powder Coated galvanized steel Interior /Exterior White
Capacity	1071 Litres (Gross)
Dimensions	1286W x 762D x 2220H
Weight	221Kg
Operating Temp	0° - 5° C.
Ambient Temp Range	0° - 40° C.
Power Point	220 - 240v 50Hz. (Standard GPO)
Input Current	2.9 Amps
Thermometer	Digital
Shelves	8 Height Adjustable Heavy Duty PVC Coated
Shelves	2 Fixed Stainless Steel Base Shelves
Shelf Adjustment	12mm Increments
Door	2 x Self Closing, Double Glazed Safety Glass, Double Heat reflective Low E, Warm edge
Footings	Heavy Duty Castors, Lockable Front
Interior Light	LED, Automatic and manual control
Refrigerant	R134a
Drier	Solid Core
Insulation	50mm Polyurethane, CFC, HCFC, HFC Free
Cabinet Classes	3M1, 4M1, 5M1
MEPS	Compliant (High Efficiency)
* Energy Consumption	4.74 kWh/24h
Condenser Filter	Easy front access
Illuminated Advertising Sign	200mm High, Top Mounted
Sign Illumination	LED, Automatic and manual control

RRP : \$4786 + GST
Orford EB36R-Sn-A

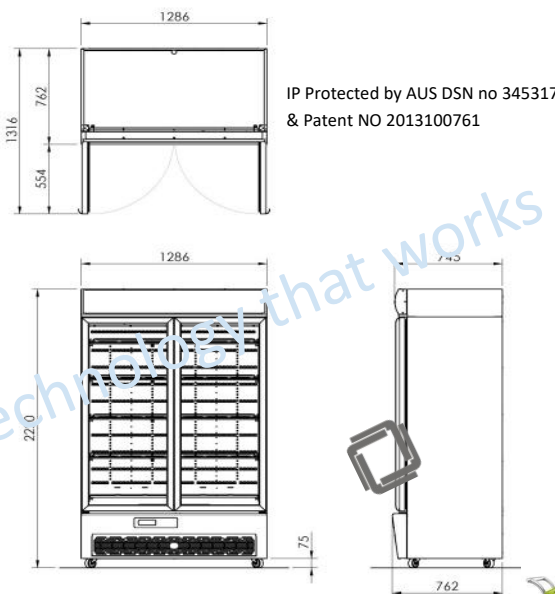

The Orford Group EB Model	Energy Consumption @3M1 kWh/24hr
EB36R-A	4.28
EB36R-SN-A with illuminated sign	4.74



Do you have an ABN?
Contact us for a trade discount!

EB36R-Sn-PT Specifications	Rear Loading Display Refrigerator with Illuminated Advertising Sign
Construction	Powder Coated galvanized steel Interior /Exterior White
Capacity	1071 Litres (Gross)
Dimensions	1286W x 762D x 2220H
Weight	221Kg
Operating Temp	0° - 5° C.
Ambient Temp Range	0° - 40° C.
Power Point	220 - 240v 50Hz. (Standard GPO)
Input Current	2.9 Amps
Thermometer	Digital
Shelves	8 Height Adjustable Heavy Duty PVC Coated
Shelves	2 Fixed Stainless Steel Base Shelves
Shelf Adjustment	12mm Increments
Door + Rear doors	2 x Self Closing, Double Glazed Safety Glass, Double Heat reflective Low E, Warm edge
Footings	2 x Self closing powdercoated doors Heavy Duty Castors, Lockable Front
Interior Light	LED, Automatic and manual control
Refrigerant	R134a
Drier	Solid Core
Insulation	50mm Polyurethane, CFC, HCFC, HFC Free
Cabinet Classes	3M1, 4M1, 5M1
MEPS	Compliant (High Efficiency)
* Energy Consumption	4.74 kWh/24h
Condenser Filter	Easy front access
Illuminated Advertising Sign	200mm High, Top Mounted
Sign Illumination	LED, Automatic and manual control

RRP : \$5193 + GST
Orford EB36R-Sn-A-PT

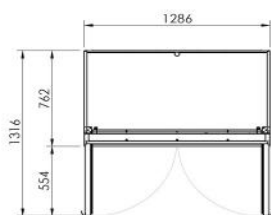

IP Protected by AUS DSN no 345317
& Patent NO 2013100761

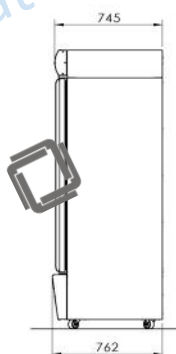
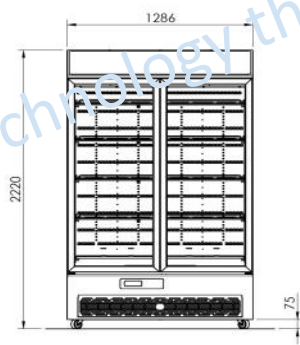

technology that works



Do you have an ABN?
Contact us for a trade discount!

EB45R-Sn Specifications	Vertical Display Refrigerator with Illuminated Advertising Sign
Construction	Powder Coated galvanized steel Interior / Exterior White
Capacity	1384 Litres (Gross)
Dimensions	1640W x 762D x 2220H
Weight	265 Kg
Operating Temp	0° - 5° C.
Ambient Temp Range	0° - 40° C.
Power Point	220 - 240v 50Hz. (Standard GPO)
Input Current	3.2 Amps
Thermometer	Digital
Shelves	12 Height Adjustable Heavy Duty PVC Coated
Shelves	3 Fixed Stainless Steel Base Shelves
Shelf Adjustment	12mm Increments
Refrigerated Shelf Area	3.38 m ²
Condensate Disposal	Automatic by energy efficient, No Cost, Hot Gas 3 x Self Closing, Double Glazed Safety Glass,
Door	Double Heat reflective Low E, Warm edge
Footings	Heavy Duty Castors, Lockable Front
Interior Light	LED, Automatic and manual control
Refrigerant	R134a
Cabinet Classes	3M1, 4M1, 5M1
MEPS	Compliant (High Efficiency)
* Energy Consumption	6.03 kWh/24h
Condenser Filter	Easy front access
Illuminated Advertising Sign	200mm High, Top Mounted
Sign Illumination	LED, Automatic and manual control

RRP : \$5907 + GST
Orford EB45R-Sn-A

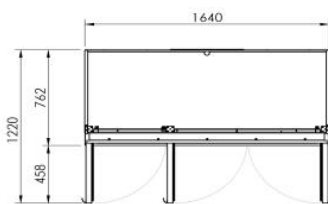

IP Protected by AUS DSN no
345317 & Patent NO 2013100761

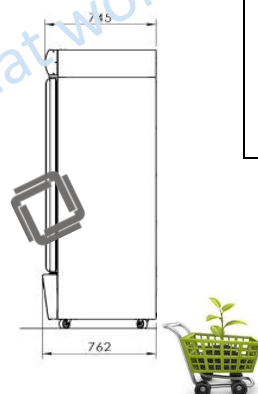
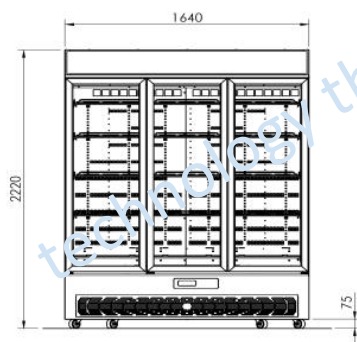

The Orford Group EB Model	Energy Consumption @3M1 kWh/24hr
EB45R-A	5.45
EB45R-SN-A with illuminated sign	6.03



Do you have an ABN?
Contact us for a trade discount!

EB45R-Sn-PT Specifications	Rear Loading Display Refrigerator with Illuminated Advertising Sign
Construction	Powder Coated galvanized steel Interior / Exterior White
Capacity	1384 Litres (Gross)
Dimensions	1640W x 762D x 2220H
Weight	265 Kg
Operating Temp	0° - 5° C.
Ambient Temp Range	0° - 40° C.
Power Point	220 - 240v 50Hz. (Standard GPO)
Input Current	3.2 Amps
Thermometer	Digital
Shelves	12 Height Adjustable Heavy Duty PVC Coated
Shelves	3 Fixed Stainless Steel Base Shelves
Shelf Adjustment	12mm Increments
Refrigerated Shelf Area	3.38 m ²
Condensate Disposal	Automatic by energy efficient, No Cost, Hot Gas 3 x Self Closing, Double Glazed Safety Glass, Double Heat reflective Low E, Warm edge
Door	3 x Self closing powder coated rear doors Heavy Duty Castors, Lockable Front
Footings	LED, Automatic and manual control
Interior Light	R134a
Refrigerant	Compliant (High Efficiency)
Cabinet Classes	3M1, 4M1, 5M1
MEPS	6.03 kWh/24h
* Energy Consumption	Easy front access
Condenser Filter	200mm High, Top Mounted
Illuminated Advertising	LED, Automatic and manual control
Sign	
Sign Illumination	

RRP : \$6480 + GST
Orford EB45R-Sn-PT

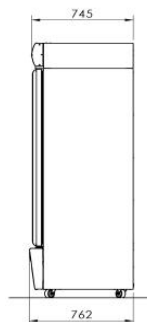
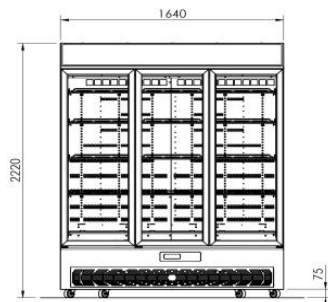
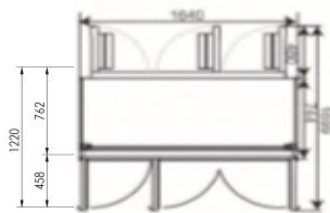

IP Protected by AUS DSN no 345317
& Patent NO 2013100761



Do you have an ABN?
Contact us for a trade discount!



The Orford Group Patented EB Model	Energy Consumption @ 3M1 kWh/24hr	Running Cost based on power at .28c per kW
EB20R-A	3.17	3.17 @ .28c = .89c per day = \$324.84 per annum
EB20R-Sn-A (with sign box)	3.43	3.43 @ .28c = .96c per day = \$350.40 per annum
EB30R-A	3.78	3.78 @ 28c = \$1.06c per day = \$386.90 per annum
EB30R-Sn-A (with sign box)	4.24	4.24 @ 28c = \$1.19 per day = \$434.35 per annum
EB36R-A	4.28	4.28 @ 28c = \$1.20 per day = \$428.00 per annum
EB36R-Sn-A (with sign box)	4.74	4.74 @ 28c = \$1.33 per day = \$485.45 per annum
EB45R-A	5.45	5.45 @ 28c = \$1.53 per day = \$558.45 per annum
EB45R-Sn-A (with sign box)	6.03	6.03 @ 28c = \$1.69 per day = \$616.85 per annum



1920 - 2020 - 100 Years Young



technology that works

IP Protected by AUS DSN no 345317
& Patent NO 2013100761





Halo HR350 Slim

Do you have an ABN?
Contact us for a trade discount!



Halo HR350-B Slim RRP \$1592 + GST

The Halo HR 350—B Slim offers eye catching appeal to increase impulse sales. A versatile and energy efficient solution for your cooling requirements.

Quiet enough for Commercial or Domestic application

www.orford.com.au for specification sheet

Specifications	Slim Impulse HR350-B Display Fridge
Brand	Halo
Model	HR350-B
Maximum Ambient Temp	35°C (Perishables in maximum 25°C air conditioning)
Temp Range	+1°C to +10°C
Capacity /L	339 Litres
Refrigerant	R600a
External Dims in mm	640 w x 670 d x 1940 h
Internal Dims in mm	530 w x 430 d x 1205 h
Thermometer	Dixell Electronic Controller with dust cover
Shelves	4 adjustable shelves with rear product stop and front ticket stripping
Door	1 swing door hinged on the right with lock
Footings	Stabiliser feet, rear 25mm castors
Interior Light	Single LED light
Weight	75kg
Light switches	Separate light box switch and cabinet light switch
Power Point	10Amp GPO
Input power	1.84 kW/24h

- Elegant Slim-lined styled, display refrigerator for storage and impulse merchandising
- White in colour with Cool Grey Trim
- Strong well constructed body
- LED light, offering, long life, brilliant merchandising, stunning product visibility and energy savings
- Dixell controller with dust cover protects small fingers
- Low Global Warming Refrigerant R600a
- Lockable self closing doors
- Independent light switches for internal light and signbox





halo®

Halo TF85 Impulse

Do you have an ABN?
Contact us for a trade discount!



Halo® TF-85 Countertop Fridge RRP \$900 + GST

The Halo TF-85 counter top offers eye catching appeal to increase impulse sales. A versatile and energy efficient solution for your cooling requirements.

www.orford.com.au

Certificate of Suitability No : AZ 69023706

Features

- ◆ Elegant Slim-line styled, Reach-in Display Fridge for Storage and Merchandising
- ◆ Strong well-constructed body
- ◆ LED Light, offering, Long life, brilliant merchandising, stunning product visibility and energy savings.
- ◆ Energy efficient, self-closing glass door
- ◆ Plug and Use—power requirements Standard 10 Amp. Power point
- ◆ Low Global Warming Refrigerant R600a adding a new dimension to environmental efficiency.
- ◆ Easy grip integrated handle

Halo TF-85 Specifications

Countertop Impulse Refrigerator

Construction	Powder Coated galvanized steel Interior / Exterior White
Capacity	85 Ltr
Dimensions	505 w x 590 d x 780 H External 410 w x 395 d x 625 H Internal
Weight	35 kg
Operating Temp	0° - 10° C.
Ambient Temperature	32° C.
Power Point	220 - 240v 50Hz. (Standard GPO)
Thermometer	Mechanical thermometer control
Shelves	4 Height Adjustable Heavy Duty PVC Coated
Shelves	3 Removable shelves
Condensate Disposal	Automatic by energy efficient, No Cost, Hot Gas
Door	1 x Safety Glass, With door locks
Footings	2 adjustable feet at front and 2 rollers at the back
Interior Light	LED (on/off switch included)
Refrigerant	R600a
Insulation	Polyurethane, CFC, HCFC, HFC Free
Power Supply	1 x 10 AMP

orford
REFRIGERATION



A close-up photograph of a clear glass filled with vibrant red sorbet. A cooked lobster claw is perched on top of the sorbet. The background is softly blurred, showing hints of green leaves. The text 'freezer -general' is overlaid in white on the right side of the glass.

freezer
-general

Do you have an ABN?
Contact us for a trade discount!

VB36L-Sn-A Specifications	Vertical Display Ice Freezer with Illuminated Advertising Sign
Construction	Powder Coated galvanized steel Interior /Exterior White
Capacity	1071 Litres (Gross)
Dimensions	1286W x 866 D (+82 overhang = 952mm total) x 2215H (mm)
Weight	250 Kg (net)
Operating Temp	-19° to -23° C.
Ambient Temp Range	0° - 40° C.
Power Point	220 - 240v 50Hz. (15AMP power outlet)
Input Current	6.3 Amps
Thermometer	Digital
Shelves	8 Height Adjustable Heavy Duty PVC Coated
Shelves	2 Fixed Stainless Steel Base Shelves
Shelf Adjustment	12mm Increments
Refrigerated Shelf Area	2.62 m ²
Condensate Disposal	Automatic by energy efficient, No Cost, Hot Gas
Full Handled Door	2 x Self Closing, Triple Glazed Safety Glass, Argon filled with Double Heat reflective Low E, Warm edge with removable torsion bar, heated frame
Footings	Heavy Duty Castors, Lockable Front
Interior Light	LED, Automatic and manual control
Refrigerant	R404a
Drier	Solid Core
Insulation	60mm Polyurethane, CFC, HCFC, HFC Free
Cabinet Classes	3L1, 4L2, 5L3 up to 40 degree Celsius ambient
MEPS	Compliant (High Efficiency)
* Energy Consumption	20.73 kWh/24h/m2
Condenser Filter	Easy front access
Illuminated Advertising Sign	205mm High, Top Mounted
Sign Illumination	LED, Automatic (motion sensor control) and manual control
Temperature Alarms	High and low temperature alarms
HACCP Function	Alarm system
Defrost	Energy Efficient Hot Gas
Sign Illumination	LED, Automatic and manual control

FREEZERS

Orford VB36L-Sn-A Freezer

RRP : \$8885 + GST

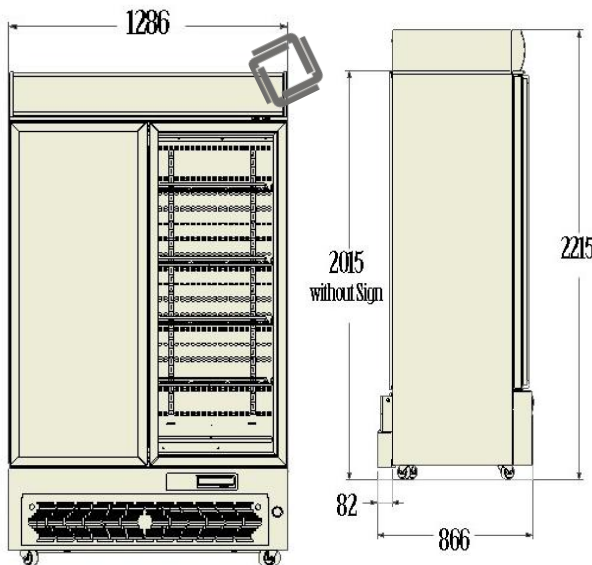

The Orford Group

VB Freezer Model

VB36L-Sn-A

Energy Consumption

@3L1 kWh/24hr

20.73

Introducing the 2016 Orford Bottom Mount VB36L-Sn-A Freezer with a removable package.

Matches the Orford EB Range

100% designed by the Orford Engineering Team

Patent Protected in Australia & New Zealand



The Orford Minus22 Freezer Series

Present your frozen food beautifully to your customer with the new

Orford *Minus22 Freezer Range*

Available in 1 door, 2 door and 3 door



Model	Temp	Doors	Net Volume	Shelves	Dimensions	RRP Price
FML-20	-18 to -22	1	560	4	750 w x 760 d x 2051 h	\$4275 + GST
FML-30	-18 to -22	2	960	8	1253 w x 760 d x 2051 h	\$5567 + GST
FML-50	-18 to -22	3	1480	12	1880 w x 760 d x 12051 h	\$6920 + GST

Do you have an ABN?
Contact us for a trade discount!



The Orford Minus22 Freezer Series



Do you have an ABN?
Contact us for a trade discount!

<i>Orford Freezer FML20</i>	Vertical Display Freezer
Specifications	
Construction	Powder Coated galvanized steel Interior /Exterior White standard (black optional)
FML-20	1 DOOR FREEZER
Capacity	560 Litres (gross)
Dimensions	750 w x 760 D x 2051 H (mm)
Weight	150kg (net)
Temp	-18c--22c
Doors	1 x Self Closing, Triple Glazed Safety Glass, Argon filled with Double Heat reflective Low E,
Ambient temp	32c degrees
Weight	166 Kg (net)
Power Point	220—240v (1 x 10 AMP powerpoint)
* Energy Consumption	12.7 kWh/24h/m2
Common Specifications	FML20 / FML30 / FML50
Compressor	Danfoss
Thermometer	Digital Elitech Controller
Shelves per door	4 Height Adjustable Heavy Duty PVC Coated
Shelf Adjustment	12mm Increments
Condensate Disposal	Automatic by energy efficient, No Cost, Hot Gas
Footings	Heavy Duty 2.5mm Castors, Lockable Front
Interior Light	LED light with light switch
Refrigerant	R404a
Drier	Solid Core to suit
Insulation	60mm Polyurethane, CFC, HCFC, HFC Free
Cabinet Classes	
Condenser Filter	Easy front access
Security	Freezer has lock and key
Drip Tray Evaporation	Hot Gas
Method	
Kick Panel	Easy unclip and remove system
Defrost	Energy Efficient Hot Gas
Compliance	MEPS, EMC,

Orford FML-20 Freezer

RRP \$4275 + GST



The Orford Minus22 Freezer Series



Do you have an ABN?
Contact us for a trade discount!

<i>Orford Freezer FML30</i>	2 Door Vertical Display Freezer
Specifications	
Construction	Powder Coated galvanized steel Interior /Exterior White
FML-30	2 DOOR FREEZER
Capacity	930 Litres (gross)
Dimensions	1253 w x 760 D x 2051 H (mm)
Weight	240 kg (net)
Doors	2 x Self Closing, Triple Glazed Safety Glass, Argon filled with Double Heat reflective Low E,
Temp	-18—-22c degrees
Ambient Temperature	32 degrees
Power Point	1 x 15 AMP plug
* Energy Consumption	22.4 kWh/24h/m2
Common Specifications	FML20 / FML30 / FML50
Compressor	Danfoss
Thermometer	Digital Elitech Controller
Shelves per door	4 Height Adjustable Heavy Duty PVC Coated
Shelf Adjustment	12mm Increments
Condensate Disposal	Automatic by energy efficient, No Cost, Hot Gas
Footings	Heavy Duty 2.5mm Castors, Lockable Front
Interior Light	LED light
Refrigerant	R404a
Drier	Solid Core
Insulation	60mm Polyurethane, CFC, HCFC, HFC Free
Cabinet Classes	
Condenser Filter	Easy front access
Security	Freezer has lock and key
Drip Tray Evaporation Method	Hot Gas
Kick Panel	Easy unclip and remove system
Defrost	Energy Efficient Hot Gas
Compliance	MEPS, EMC,

Orford FML-30 Freezer

RRP \$5567 + GST



The Orford Minus22 Freezer Series



Do you have an ABN?
Contact us for a trade discount!

<i>Orford Freezer FML-50</i>	3 Door Vertical Display Freezer
Specifications	
Construction	Powder Coated galvanized steel Interior / Exterior White
FML-50	3 DOOR FREEZER
Capacity	1450 Litres (gross)
Dimensions	1880 w x 760 D x 2051 H (mm)
Weight	305 kg (net)
Doors	3 x Self Closing, Triple Glazed Safety Glass, Argon filled with Double Heat reflective Low E,
* Energy Consumption	34.3 kWh/24h/m ²
Operating Temp	-18° to -22° C.
Ambient Temp Range	32 degrees
Power Point	220 - 240v 50Hz. (1 x 15 AMP power outlet)
Common Specifications	FML20 / FML30 / FML50
Compressor	Danfoss
Thermometer	Digital Elitech Controller
Shelves per door	4 Height Adjustable Heavy Duty PVC Coated with 1 Fixed Stainless Steel Base shelves
Shelf Adjustment	12mm Increments
Condensate Disposal	Automatic by energy efficient, No Cost, Hot Gas
Footings	Heavy Duty 2.5mm Castors, Lockable Front
Interior Light	LED light
Refrigerant	R404a
Drier	Solid Core
Insulation	60mm Polyurethane, CFC, HCFC, HFC Free
Cabinet Classes	
Condenser Filter	Easy front access
Security	Freezer has lock and key
Drip Tray Evaporation Method	Hot Gas
Kick Panel	Easy unclip and remove system
Defrost	Energy Efficient Hot Gas
Compliance	MEPS, EMC,

Orford FML-50 Freezer

RRP \$6920 + GST





halo®

Halo Freezer Range

Do you have an ABN?

Contact us for a trade discount!



Halo TGF-5SD

Specifications

Construction	Colorbond Inner and Outer
Capacity	167 Litres (Gross)
Dimensions	635.W x 590 D x 775 H Exterior
Weight	83 Kg
Operating Temp	-16° - 24° C.
Ambient Temp Range	0° - 32° C.
Power Point	220 - 240v 50Hz. (Standard GPO)
Plug	1 x 10 Amps
Thermometer	Digital
Shelves	2 Height Adjustable Heavy Duty PVC Coated
Door	1 x Swinging, glass self closing doors
Interior Light	LED, Automatic and manual control
Refrigerant	R404a
Sign Illumination	LED, Automatic and manual control

Vertical Display 167 Lt Freezer

RRP \$4070 + GST

Halo TGF-10SD

Specifications

Construction	Colorbond Inner and Outer
Capacity	263 Litres (Gross)
Dimensions	655.W x 590 D x 1380 H Exterior
Weight	89 Kg
Operating Temp	-16° - 24° C.
Ambient Temp Range	0° - 32° C.
Power Point	220 - 240v 50Hz. (Standard GPO)
Plug	1 x 10 Amps
Thermometer	Digital
Shelves	3 Height Adjustable Heavy Duty PVC Coated
Door	1 x Swinging, glass self closing door
Interior Light	LED, Automatic and manual control
Refrigerant	R404a
Sign Illumination	LED, Automatic and manual control

Vertical Display 263 Lt Freezer

RRP \$5400 + GST



Halo TGF-15SD

Specifications

Construction	Colorbond Inner and Outer
Capacity	450 Litres (Gross)
Dimensions	670.W x 630 D x 1920 H Exterior
Weight	142 Kg
Operating Temp	-16° - 24° C.
Ambient Temp Range	0° - 32° C.
Power Point	220 - 240v 50Hz. (Standard GPO)
Plug	1 x 10 Amps
Thermometer	Digital
Shelves	5 Height Adjustable Heavy Duty PVC Coated
Door	1 x Swinging, glass self closing door
Interior Light	LED, Automatic and manual control
Refrigerant	R404a
Sign Illumination	LED, Automatic and manual control

Vertical Display 450 Lt Freezer

RRP \$6550 + GST



Orford
REFRIGERATION



specialities



Do you have an ABN?
Contact us for a trade discount!

EB30R-Sn-Flower Specifications	Vertical Flower Refrigerator with Illuminated Advertising Sign
Flower Cabinet	Designed to extend the shelf life of fresh flowers
Capacity	895 Litres (Gross)
Dimensions	1094W x 762D x 2220H
Weight	210Kg
Florist Benefits	Temperature Management for flowers
Colours	Ebony Black, and Snow White
Power Point	220 - 240v 50Hz. (Standard GPO)
Input Current	2.9 Amps
Thermometer	Digital
Shelves	8 Height Adjustable Heavy Duty PVC Coated
Shelves	2 Fixed Stainless Steel Base Shelves
Shelf Adjustment	12mm Increments
Door	2 x Self Closing, Double Glazed Safety Glass, Double Heat reflective Low E, Warm edge
Footings	Heavy Duty Castors, Lockable Front
Interior Light	LED, Automatic and manual control
Refrigerant	R134a
Cabinet Classes	3M1, 4M1, 5M1
MEPS	Compliant (High Efficiency)
* Energy Consumption	4.24 kWh/24h
Condenser Filter	Easy front access
Illuminated Advertising Sign	200mm High, Top Mounted
Sign Illumination	LED, Automatic and manual control

RRP : \$4324 + GST
Orford EB30R-Sn-A-Flower



Daily running costs based on power costs of .28c per kW

- \$1.20 per day with sign box off
- \$1.33 per day with sign box on

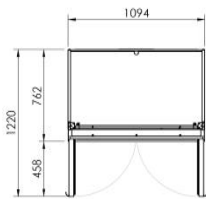

IP Protected by AUS DSN no 345317
& Patent NO 2013100761

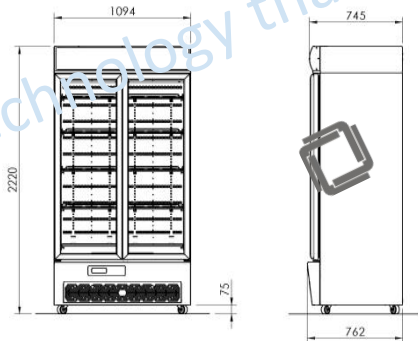

Flower Fridges 4 U

For more information on the Orford Group flower Range including features & benefits refer to

www.flowerfridges4u.com.au



Do you have an ABN?
Contact us for a trade discount!

EB36R-Sn-Flower Specifications	Vertical Flower Refrigerator with Illuminated Advertising Sign
Flower Cabinet	Designed to extend the shelf life of fresh flowers
Capacity	1071 Litres (Gross)
Dimensions	1286W x 762D x 2220H
Weight	221Kg
Florist Benefits	Temperature Management for flowers
Colours	Ebony Black, and Snow White
Power Point	220 - 240v 50Hz. (Standard GPO)
Input Current	2.9 Amps
Thermometer	Digital
Shelves	8 Height Adjustable Heavy Duty PVC Coated
Shelves	2 Fixed Stainless Steel Base Shelves
Shelf Adjustment	12mm Increments
Door	2 x Self Closing, Double Glazed Safety Glass, Double Heat reflective Low E, Warm edge
Footings	Heavy Duty Castors, Lockable Front
Interior Light	LED, Automatic and manual control
Refrigerant	R134a
Cabinet Classes	3M1, 4M1, 5M1
MEPS	Compliant (High Efficiency)
* Energy Consumption	4.74 kWh/24h
Condenser Filter	Easy front access
Illuminated Advertising Sign	200mm High, Top Mounted
Sign Illumination	LED, Automatic and manual control

RRP : \$4786 + GST
Orford EB36R-Sn-A-Flower



Daily running costs based on power costs of .28c per kW

- \$1.20 per day with sign box off
- \$1.33 per day with sign box on

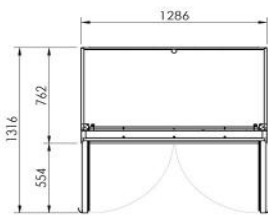

IP Protected by AUS DSN no 345317 & Patent NO 2013100761

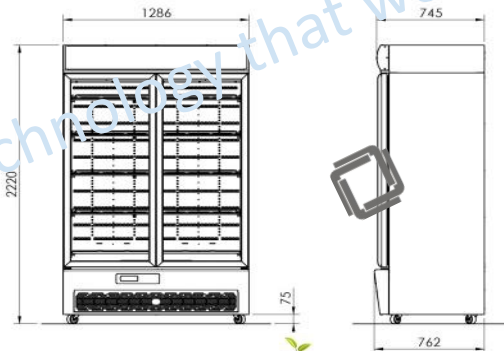

Flower Fridges 4 U

For more information on the Orford Group flower Range including features & benefits refer to

www.flowerfridges4u.com.au





The Orford Flower Fridge Range now comes in a Rear Loading version.

Position your Flower Fridge next to your counter allowing customers to access from the front doors while you continue to restock from the rear doors

RRP : \$5193 + GST

Orford EB36R-Sn-Flower- Pass Thru



RRP : \$6480 + GST

EB45R-Sn-Flower- Pass Thru



Do you have an ABN?
Contact us for a trade discount!



For more information on the Orford Group flower Range including features & benefits refer to

www.flowerfridges4u.com.au



Do you have an ABN?
Contact us for a trade discount!

EB45R-Sn-Flower Specifications	Vertical Flower Refrigerator with Illuminated Advertising Sign
Flower Cabinet	Designed to extend the shelf life of fresh flowers
Capacity	1384 Litres (Gross)
Dimensions	1640W x 762D x 2220H
Weight	265 Kg
Florist Benefits	Temperature Management for flowers
Colours	Ebony Black, and Snow White
Power Point	220 - 240v 50Hz. (Standard GPO)
Input Current	3.2 Amps
Thermometer	Digital
Shelves	12 Height Adjustable Heavy Duty PVC Coated
Shelves	3 Fixed Stainless Steel Base Shelves
Shelf Adjustment	12mm Increments
Door	3 x Self Closing, Double Glazed Safety Glass, Double Heat reflective Low E, Warm edge
Footings	Heavy Duty Castors, Lockable Front
Interior Light	LED, Automatic and manual control
Refrigerant	R134a
Cabinet Classes	3M1, 4M1, 5M1
MEPS	Compliant (High Efficiency)
* Energy Consumption	6.03 kWh/24h
Condenser Filter	Easy front access
Illuminated Advertising Sign	200mm High, Top Mounted
Sign	
Sign Illumination	LED, Automatic and manual control

RRP : \$5907 + GST
EB45R-Sn-A-Flower

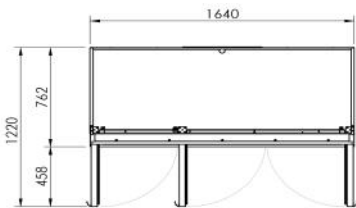

IP Protected by AUS DSN no 345317 & Patent NO 2013100761

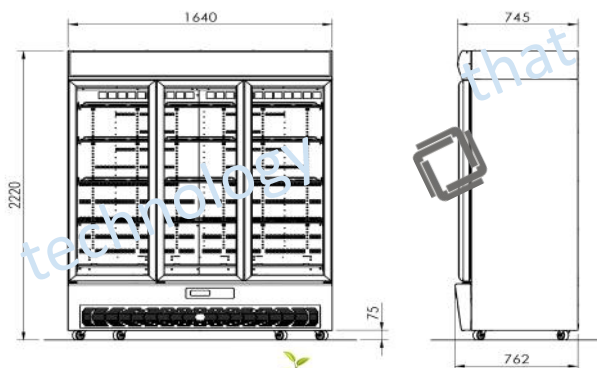

Daily running costs based on power costs of .28c per kW

- \$1.53 per day with sign box off
- \$1.69 per day with sign box on



Flower Fridges 4 U

For more information on the Orford Group flower Range including features & benefits refer to

www.flowerfridges4u.com.au





Do you have an ABN?
Contact us for a trade discount!

FMB20-Sn-Wine	Vertical Display Refrigerator with Illuminated Advertising Sign
Construction	Powder Coated galvanized steel Int / Ext White
Capacity	557Litres (Gross)
Dimensions	740W x 791D x 2200H
Weight	165Kg
Operating Temp	0° - 5° C.
Ambient Temp Range	0° - 40° C.
Power Point	230 - 240v 50Hz. (Standard GPO)
Thermometer	Digital Carel Controller
Shelves	4 Height Adjustable Heavy Duty PVC Coated
Shelf Adjustment	12mm Increments
Door	Self Closing, Double Glazed Safety Glass, Argon filled Single Heat reflective Low E, Right Hand hinged.
Footings	Heavy Duty Castors, Lockable Front
Compressor	Danfoss
Interior Light	LED (on/off switch included)
Refrigerant	R134A
Insulation	50mm Polyurethane, CFC, HCFC, HFC Free
Climate Class	Class 5
MEPS	Compliant (High Efficiency)
Condenser Filter	Rear mounted
Illuminated Advertising Sign	200mm High, Top Mounted.
Sign	LED
Sign Illumination	LED

Orford FMB20Sn-wine
RRP : \$2745 + GST



FMB30-Sn-Wine	Vertical Display Wine Refrigerator with Illuminated Advertising Sign
Construction	Powder Coated galvanized steel Int/ Ext White
Capacity	889 Litres (Gross)
Dimensions	1130W x 791D x 2200H
Weight	210Kg
Operating Temp	0° - 5° C.
Ambient Temp Range	0° - 40° C.
Power Point	230 - 240v 50Hz. (Standard GPO)
Thermometer	Digital Carel Controller
Shelves	8 Height Adjustable Heavy Duty PVC Coated
Shelf Adjustment	12mm Increments
Door	Self Closing, Double Glazed Safety Glass, Argon filled Single Heat reflective Low E, Right Hand hinged.
Footings	Heavy Duty Castors, Lockable Front
Compressor	Danfoss
Interior Light	LED (on/off switch included)
Refrigerant	R134A
Insulation	50mm Polyurethane, CFC, HCFC, HFC Free
Climate Class	Class 5
MEPS	Compliant (High Efficiency)
Condenser Filter	Rear mounted
Illuminated Advertising Sign	200mm High, Top Mounted.
Sign	LED
Sign Illumination	LED

Orford FMB30Sn-Wine
RRP : \$3265 + GST





PlanetSmart™ EB Wine Range

Do you have an ABN?
Contact us for a trade discount!

EB20R-Sn-Wine Specifications	Vertical Display Wine Refrigerator with Illuminated Advertising Sign
Construction	Powder Coated galvanized steel Interior / Exterior White
Capacity	595 Litres (Gross)
Dimensions	756W x 762D x 2220H
Weight	155Kg
Operating Temp	0° - 5° C.
Ambient Temp Range	0° - 40° C.
Power Point	220 - 240v 50Hz. (Standard GPO)
Input Current	2.8 Amps
Thermometer	Digital
Shelves	4 Height Adjustable Heavy Duty PVC Coated
Shelves	1 Fixed Stainless Steel Base Shelves
Shelf Adjustment	12mm Increments
Refrigerated Shelf Area	1.42 m ²
Condensate Disposal	Automatic by energy efficient, No Cost, Hot Gas
Door	1 x Self Closing, Double Glazed Safety Glass, Double Heat reflective Low E, Warm edge, R/H
Footings	Heavy Duty Castors, Lockable Front
Interior Light	LED, Automatic and manual control
Refrigerant	R134a
Drier	Solid Core
Insulation	50mm Polyurethane, CFC, HCFC, HFC Free
Cabinet Classes	3M1, 4M1, 5M1
MEPS	Compliant (High Efficiency)
* Energy Consumption	3.43 kWh/24h
Condenser Filter	Easy front access
Illuminated Advertising Sign	200mm High, Top Mounted
Sign Illumination	LED, Automatic and manual control

RRP : \$3800 + GST
Orford EB20R-Sn-A-Wine

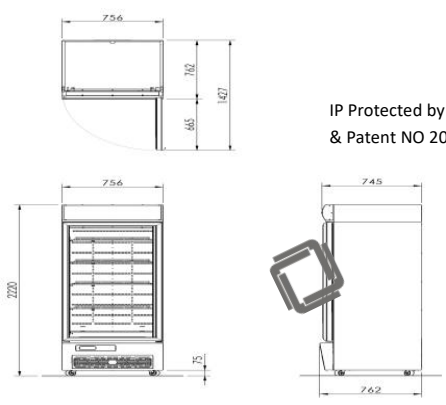

IP Protected by AUS DSN no 345317
& Patent NO 2013100761



The Orford Group EB20 Wine Cabinet	Energy Consumption @3M1 kWh/24hr
EB20R-SN-A with sign	3.43





PlanetSmart™ EB Wine Range

Do you have an ABN?
Contact us for a trade discount!

EB30R-Sn-wine Specifications

Vertical Wine Display Refrigerator with Illuminated Advertising Sign

Construction	Powder Coated galvanized steel Interior /Exterior White
Capacity	895 Litres (Gross)
Dimensions	1094W x 762D x 2220H
Weight	210Kg
Operating Temp	0° - 5° C.
Ambient Temp Range	0° - 40° C.
Power Point	220 - 240v 50Hz. (Standard GPO)
Input Current	2.8 Amps
Thermometer	Digital
Shelves	8 Height Adjustable Heavy Duty PVC Coated
Shelves	2 Fixed Stainless Steel Base Shelves
Shelf Adjustment	12mm Increments
Refrigerated Shelf Area	2.17 m ²
Condensate Disposal	Automatic by energy efficient, No Cost, Hot Gas
Door	2 x Self Closing, Double Glazed Safety Glass, Double Heat reflective Low E, Warm edge
Footings	Heavy Duty Castors, Lockable Front
Interior Light	LED, Automatic and manual control
Refrigerant	R134a
Cabinet Classes	3M1, 4M1, 5M1
MEPS	Compliant (High Efficiency)
* Energy Consumption	4.24 kWh/24h
Condenser Filter	Easy front access
Illuminated Advertising Sign	200mm High, Top Mounted
Sign Illumination	LED, Automatic and manual control

RRP : \$4324 + GST
EB30R-Sn-A-wine



Bar Fridges 4 U
www.barfridges4u.com.au

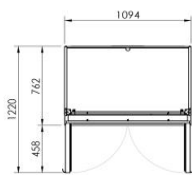

IP Protected by AUS DSN no 345317
& Patent NO 2013100761

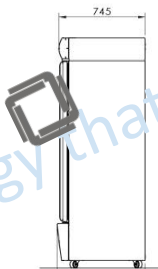
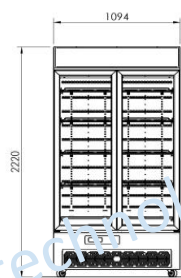

The Orford Group EB Model

Energy Consumption
@3M1 kWh/24hr

EB30R-SN-A with sign

4.24





PlanetSmart™ EB Wine Range

Do you have an ABN?
Contact us for a trade discount!

EB36R-Sn-Wine Specifications	Vertical Wine Refrigerator with Illuminated Advertising Sign
Wine Cabinet	
Capacity	1071 Litres (Gross)
Dimensions	1286W x 762D x 2220H
Weight	221Kg
Florist Benefits	Temperature Management for flowers
Colours	Ebony Black, and Snow White
Power Point	220 - 240v 50Hz. (Standard GPO)
Input Current	2.9 Amps
Thermometer	Digital
Shelves	8 Height Adjustable Heavy Duty PVC Coated
Shelves	2 Fixed Stainless Steel Base Shelves
Shelf Adjustment	12mm Increments
Door	2 x Self Closing, Double Glazed Safety Glass, Double Heat reflective Low E, Warm edge
Footings	Heavy Duty Castors, Lockable Front
Interior Light	LED, Automatic and manual control
Refrigerant	R134a
Cabinet Classes	3M1, 4M1, 5M1
MEPS	Compliant (High Efficiency)
* Energy Consumption	4.74 kWh/24h
Condenser Filter	Easy front access
Illuminated Advertising Sign	200mm High, Top Mounted
Sign Illumination	LED, Automatic and manual control

RRP : \$4786 + GST
EB36R-Sn-A-Wine

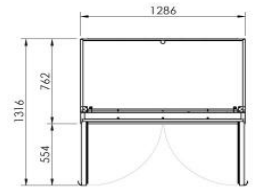

IP Protected by AUS DSN no 345317
& Patent NO 2013100761



Bar Fridges 4 U
www.barfridges4u.com.au

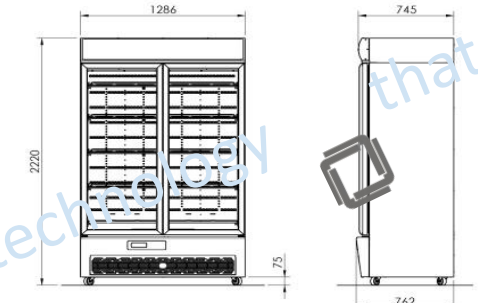

Daily running costs based on power costs of .28c per kW

- \$1.20 per day with sign box off
- \$1.33 per day with sign box on

For more information on the Orford Group Wine and Bar Range including features & benefits refer to





PlanetSmart™ EB Wine Range

Do you have an ABN?
Contact us for a trade discount!

EB45R-Sn-Wine Specifications	Vertical Wine Refrigerator with Illuminated Advertising Sign
Wine Cabinet	
Capacity	1384 Litres (Gross)
Dimensions	1640W x 762D x 2220H
Weight	265 Kg
Florist Benefits	Temperature Management for flowers
Colours	Ebony Black, and Snow White
Power Point	220 - 240v 50Hz. (Standard GPO)
Input Current	3.2 Amps
Thermometer	Digital
Shelves	12 Height Adjustable Heavy Duty PVC Coated
Shelves	3 Fixed Stainless Steel Base Shelves
Shelf Adjustment	12mm Increments
Door	3 x Self Closing, Double Glazed Safety Glass, Double Heat reflective Low E, Warm edge
Footings	Heavy Duty Castors, Lockable Front
Interior Light	LED, Automatic and manual control
Refrigerant	R134a
Cabinet Classes	3M1, 4M1, 5M1
MEPS	Compliant (High Efficiency)
* Energy Consumption	6.03 kWh/24h
Condenser Filter	Easy front access
Illuminated Advertising Sign	200mm High, Top Mounted
Sign	
Sign Illumination	LED, Automatic and manual control

RRP : \$5907 + GST
EB45R-Sn-A-Wine



Daily running costs based on power costs of .28c per kW

- \$1.53 per day with sign box off
- \$1.69 per day with sign box on

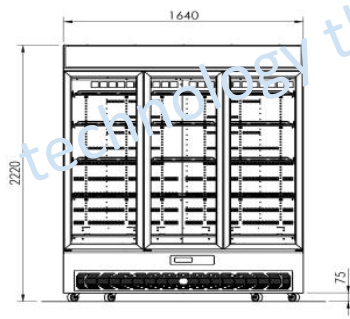
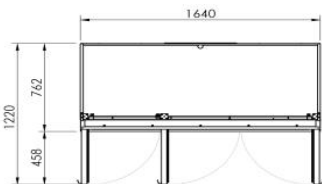

IP Protected by AUS DSN no 345317
Patent NO 2013100761

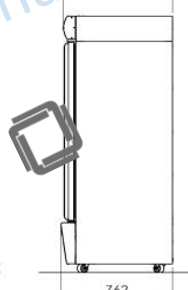

Bar Fridges 4 U
www.barfridges4u.com.au

For more information on the Orford Group Bar and Wine Range including features & benefits refer to



Do you have an ABN?
Contact us for a trade discount!

EB30R-CC-Sn Specifications	Vertical Display Choc Refrigerator with Illuminated Advertising Sign
Construction	Powder Coated galvanized steel Interior /Exterior White
Capacity	895 Litres (Gross)
Dimensions	1094W x 762D x 2220H
Weight	210Kg
Operating Temp	12° - 18° C.
Ambient Temp Range	0° - 40° C.
Power Point	220 - 240v 50Hz. (Standard GPO)
Input Current	2.8 Amps
Thermometer	Digital
Shelves	8 Height Adjustable Heavy Duty PVC Coated
Shelves	2 Fixed Stainless Steel Base Shelves
Shelf Adjustment	12mm Increments
Refrigerated Shelf Area	2.17 m ²
Condensate Disposal	Automatic by energy efficient, No Cost, Hot Gas
Door	2 x Self Closing, Double Glazed Safety Glass, Double Heat reflective Low E, Warm edge
Footings	Heavy Duty Castors, Lockable Front
Interior Light	LED, Automatic and manual control
Refrigerant	R134a
Cabinet Classes	3M1, 4M1, 5M1
MEPS	Compliant (High Efficiency)
* Energy Consumption	4.24 kWh/24h
Condenser Filter	Easy front access
Illuminated Advertising Sign	200mm High, Top Mounted
Sign Illumination	LED, Automatic and manual control

RRP : \$4324 + GST

EB30CC-Sn

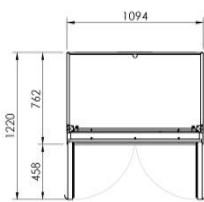

IP Protected by AUS DSN no 345317
& Patent NO 2013100761

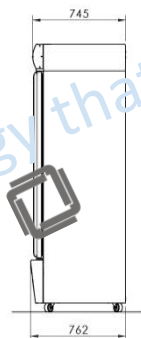
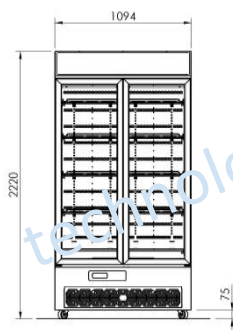

The Orford Group EB Model

Energy Consumption
@3M1 kWh/24hr

EB30R-A 3.78

EB30R-SN-A with illuminated sign 4.24

For more information on the Orford Refrigeration Chocolate Fridge Range including features & benefits refer to

www.orford.com.au



Do you have an ABN?
Contact us for a trade discount!

EB36R-CC-Sn Specifications

Vertical Display Choc Refrigerator with Illuminated Advertising Sign

Construction	Powder Coated galvanized steel Interior /Exterior White
Capacity	1071 Litres (Gross)
Dimensions	1286W x 762D x 2220H
Weight	221Kg
Operating Temp	12° - 18° C.
Ambient Temp Range	0° - 40° C.
Power Point	220 - 240v 50Hz. (Standard GPO)
Input Current	2.9 Amps
Thermometer	Digital
Shelves	8 Height Adjustable Heavy Duty PVC Coated
Shelves	2 Fixed Stainless Steel Base Shelves
Shelf Adjustment	12mm Increments
Door	2 x Self Closing, Double Glazed Safety Glass, Double Heat reflective Low E, Warm edge
Footings	Heavy Duty Castors, Lockable Front
Interior Light	LED, Automatic and manual control
Refrigerant	R134a
Drier	Solid Core
Insulation	50mm Polyurethane, CFC, HCFC, HFC Free
Cabinet Classes	3M1, 4M1, 5M1
MEPS	Compliant (High Efficiency)
* Energy Consumption	4.74 kWh/24h
Condenser Filter	Easy front access
Illuminated Advertising Sign	200mm High, Top Mounted
Sign Illumination	LED, Automatic and manual control

RRP : \$4786 + GST
EB36CC-Sn

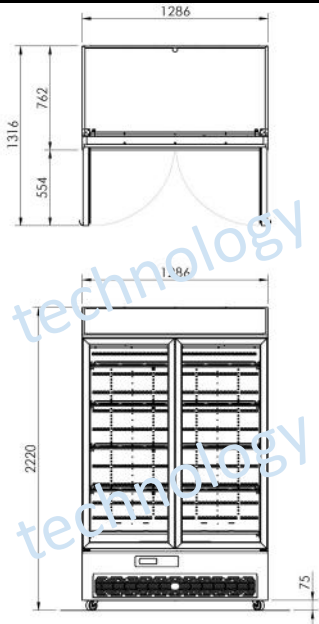

IP Protected by AUS DSN no 345317
& Patent NO 2013100761



The Orford Group EB Model	Energy Consumption @3M1 kWh/24hr
EB36R-A	4.28
EB36R-SN-A with illuminated sign	4.74

For more information on the Orford Refrigeration Chocolate Fridge Range including features & benefits refer to

www.orford.com.au



Do you have an ABN?
Contact us for a trade discount!

EB45R-Sn Specifications	Vertical Display Refrigerator with Illuminated Advertising Sign
Construction	Powder Coated galvanized steel Interior / Exterior White
Capacity	1384 Litres (Gross)
Dimensions	1640W x 762D x 2220H
Weight	265 Kg
Operating Temp	12° - 18° C.
Ambient Temp Range	0° - 40° C.
Power Point	220 - 240v 50Hz. (Standard GPO)
Input Current	3.2 Amps
Thermometer	Digital
Shelves	12 Height Adjustable Heavy Duty PVC Coated
Shelves	3 Fixed Stainless Steel Base Shelves
Shelf Adjustment	12mm Increments
Refrigerated Shelf Area	3.38 m ²
Condensate Disposal	Automatic by energy efficient, No Cost, Hot Gas 3 x Self Closing, Double Glazed Safety Glass,
Door	Double Heat reflective Low E, Warm edge
Footings	Heavy Duty Castors, Lockable Front
Interior Light	LED, Automatic and manual control
Refrigerant	R134a
Cabinet Classes	3M1, 4M1, 5M1
MEPS	Compliant (High Efficiency)
* Energy Consumption	6.03 kWh/24h
Condenser Filter	Easy front access
Illuminated Advertising Sign	200mm High, Top Mounted
Sign Illumination	LED, Automatic and manual control

RRP : \$5907 + GST
EB45CC-Sn

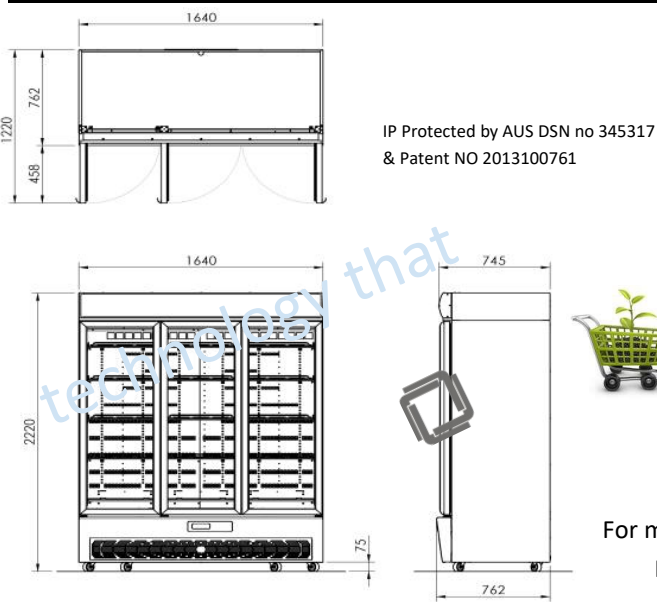

The Orford Group EB Model	Energy Consumption @3M1 kWh/24hr
EB45R-A	5.45
EB45R-SN-A with illuminated sign	6.03

For more information on the Orford Refrigeration Chocolate Fridge Range including features & benefits refer to www.orford.com.au



Café & Cake Range



Orford CDR1200

Introducing the
ORFORD Cake Fridge
& Freezer Café Range



Orford CDR1500



Orford CDF1200

Do you have an ABN?
Contact us for a trade discount!



Do you have an ABN?
Contact us for a trade discount!

CDR1200-2 Specifications	Cake Display—Tower Style
Construction	Stainless Steel—internal / external
Capacity	850 Litres (Gross)
Dimensions	1200 W x 750 D x 1350 H (mm)
Weight	310 Kg (net)
Operating Temp	2° to 8° C.
Ambient Temp Range	0° - 32° C.
Power Point	220 - 240v 50Hz. (Standard GPO)
Input Current	6.3 Amps
Thermometer	Digital
Shelves	2 Height Adjustable Heavy Duty
Refrigerated Shelf Area	2.62 m ²
Rear Door	2 x sliding doors
Footings	Heavy Duty Castors, Lockable Front
Interior Light	LED
Refrigerant	R134a
Drier	Solid Core
Insulation	60mm Polyurethane, CFC, HCFC, HFC Free

Orford CDR1200 Cake Fridge

RRP : \$5248 + GST



Display cakes beautifully in the Orford cake fridge

www.orford.com.au

sales@orford.com.au

1300 673 673

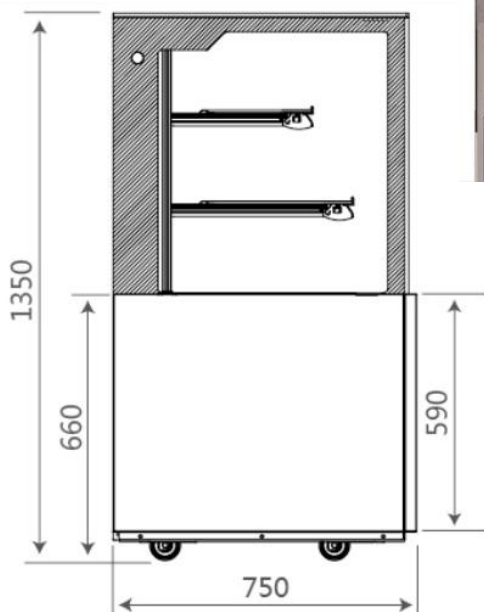

Do you have an ABN?
Contact us for a trade discount!

CDR1500-2 Specifications	Cake Display—Tower Style
Construction	Stainless Steel—internal / external
Capacity	850 Litres (Gross)
Dimensions	1500 W x 750 D x 1350 H (mm)
Weight	250 Kg (net)
Operating Temp	+2° to +8° C.
Ambient Temp Range	0° - 32° C.
Power Point	220 - 240v 50Hz. (Standard GPO)
Input Current	6.3 Amps
Thermometer	Digital
Shelves	2 Height Adjustable Heavy Duty
Refrigerated Shelf Area	2.62 m ²
Rear Door	2 x sliding doors
Footings	Heavy Duty Castors, Lockable Front
Interior Light	LED
Refrigerant	R134a
Drier	Solid Core
Insulation	60mm Polyurethane, CFC, HCFC, HFC Free

Orford CDR1500 Cake Fridge

RRP : \$6119 + GST



Display cakes beautifully in the Orford cake fridge

www.orford.com.au

sales@orford.com.au

1300 673 673

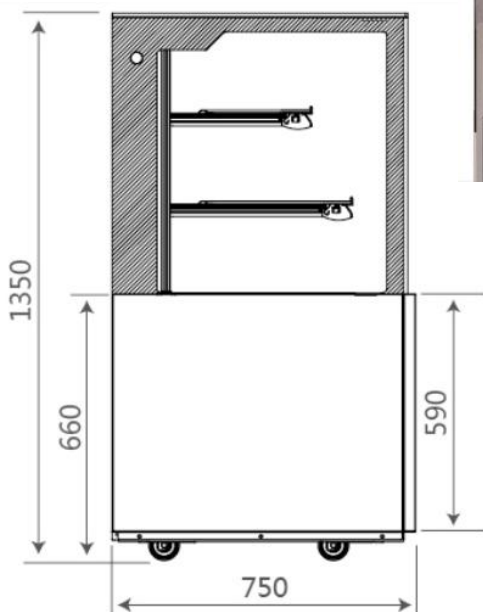



Halo Cake & Café Range

Do you have an ABN?

Contact us for a trade discount!

Halo KK1200-640 RRP 5400 + GST

Dims : 1200 w x 680 d x 1350 h (mm)

Temp : +2 to+8 c Capacity : 510L

Dixell controller, EBM condenser fan, Ambient 32 deg at 82% RH.

White LED light under each adjustable shelf

3 shelves plus base shelf



Halo KK1500-650 RRP \$6225 + GST

Dims : 1500 w x 680 d x 1350 h (mm)

Temp : +2 to+8 c Capacity : 510L

Dixell controller, EBM condenser fan,

Ambient 32 deg at 82% RH.

White LED light under each adjustable shelf

3 shelves plus base shelf



ORFORD REFRIGERATION





VB36L-Sn-IM ICE Freezer

Do you have an ABN?
Contact us for a trade discount!

VB36L-Sn-A-Ice Specifications	Vertical Display Ice Freezer with Illuminated Advertising Sign
Construction	Powder Coated galvanized steel Interior /Exterior White
Capacity	1071 Litres (Gross)
Dimensions	1286W x 866 D (+82 overhang = 952mm total) x 2215H (mm)
Weight	250 Kg (net)
Operating Temp	-19° to -23° C.
Ambient Temp Range	0° - 40° C.
Power Point	220 - 240v 50Hz. (15AMP power outlet)
Input Current	6.3 Amps
Thermometer	Digital
Shelves	8 Height Adjustable Heavy Duty PVC Coated
Shelves	2 Fixed Stainless Steel Base Shelves
Shelf Adjustment	12mm Increments
Refrigerated Shelf Area	2.62 m ²
Condensate Disposal	Automatic by energy efficient, No Cost, Hot Gas 2 x Self Closing, Triple Glazed Safety Glass, Argon filled with
Full Handled Door	Double Heat reflective Low E, Warm edge with removable torsion bar, heated frame
Footings	Heavy Duty Castors, Lockable Front
Interior Light	LED, Automatic and manual control
Refrigerant	R404a
Drier	Solid Core
Insulation	60mm Polyurethane, CFC, HCFC, HFC Free
Cabinet Classes	3L1, 4L2, 5L3 up to 40 degree Celsius ambient
MEPS	Compliant (High Efficiency)
* Energy Consumption	20.73 kWh/24h/m2
Condenser Filter	Easy front access
Illuminated Advertising Sign	205mm High, Top Mounted
Sign Illumination	LED, Automatic (motion sensor control) and manual control
Temperature Alarms	High and low temperature alarms
HACCP Function	Alarm system
Defrost	Energy Efficient Hot Gas
Sign Illumination	LED, Automatic and manual control

Orford VB36LSn—IM ICE Freezer

RRP : \$ 8885 + GST

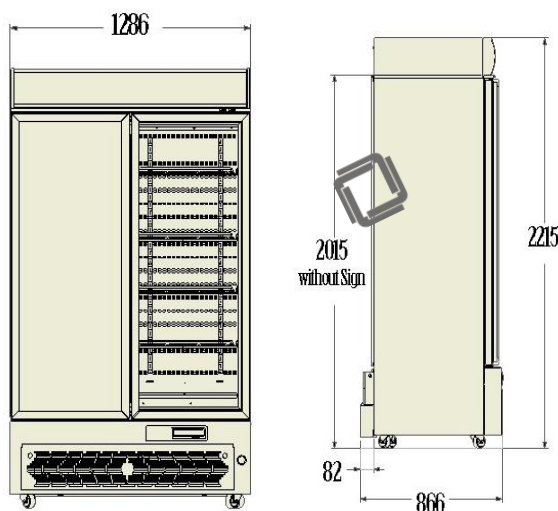

The Orford Group VB Freezer Model	Energy Consumption @31L kWh/24hr
VB36L-Sn-IM	20.73

Maximise Ice Sales with the Orford Bottom Mount Ice Freezer with a removable package.

Matches the Orford EB Range

100% designed by the Orford Engineering Team

Patent Protected in Australia & New Zealand

www.orford.com.au



The Orford Minus22 Freezer Series



Do you have an ABN?
Contact us for a trade discount!

Orford Freezer FML20	Vertical Display Ice Freezer
Specifications	
Construction	Powder Coated galvanized steel Interior /Exterior White standard (black optional)
FML-20	1 DOOR FREEZER
Capacity	560 Litres (gross)
Dimensions	750 w x 760 D x 2051 H (mm)
Weight	150kg (net)
Temp	-18c--22c
Doors	1 x Self Closing, Triple Glazed Safety Glass, Argon filled with Double Heat reflective Low E,
Ambient temp	32c degrees
Weight	166 Kg (net)
Power Point	220—240v (1 x 10 AMP powerpoint)
* Energy Consumption	12.7 kWh/24h/m2
Common Specifications	FML20 / FML30 / FML50
Compressor	Danfoss
Thermometer	Digital Elitech Controller
Shelves per door	4 Height Adjustable Heavy Duty PVC Coated
Shelf Adjustment	12mm Increments
Condensate Disposal	Automatic by energy efficient, No Cost, Hot Gas
Footings	Heavy Duty 2.5mm Castors, Lockable Front
Interior Light	LED light with light switch
Refrigerant	R404a
Drier	Solid Core to suit
Insulation	60mm Polyurethane, CFC, HCFC, HFC Free
Cabinet Classes	
Condenser Filter	Easy front access
Security	Freezer has lock and key
Drip Tray Evaporation	Hot Gas
Method	
Kick Panel	Easy unclip and remove system
Defrost	Energy Efficient Hot Gas
Compliance	MEPS, EMC,

Orford FML-20 Ice Freezer

RRP \$4275 + GST



The Orford Minus22 Freezer Series



Do you have an ABN?
Contact us for a trade discount!

<i>Orford Freezer FML30</i>	2 Door Vertical Display ice Freezer
Specifications	
Construction	Powder Coated galvanized steel Interior /Exterior White
FML-30	2 DOOR FREEZER
Capacity	930 Litres (gross)
Dimensions	1253 w x 760 D x 2051 H (mm)
Weight	240 kg (net)
Doors	2 x Self Closing, Triple Glazed Safety Glass, Argon filled with Double Heat reflective Low E,
Temp	-18—-22c degrees
Ambient Temperature	32 degrees
Power Point	1 x 15 AMP plug
* Energy Consumption	22.4 kWh/24h/m2
Common Specifications	FML20 / FML30 / FML50
Compressor	Danfoss
Thermometer	Digital Elitech Controller
Shelves per door	4 Height Adjustable Heavy Duty PVC Coated
Shelf Adjustment	12mm Increments
Condensate Disposal	Automatic by energy efficient, No Cost, Hot Gas
Footings	Heavy Duty 2.5mm Castors, Lockable Front
Interior Light	LED light
Refrigerant	R404a
Drier	Solid Core
Insulation	60mm Polyurethane, CFC, HCFC, HFC Free
Cabinet Classes	
Condenser Filter	Easy front access
Security	Freezer has lock and key
Drip Tray Evaporation Method	Hot Gas
Kick Panel	Easy unclip and remove system
Defrost	Energy Efficient Hot Gas
Compliance	MEPS, EMC,

Orford FML-30 Ice Freezer

RRP \$5567 + GST



The Orford Minus22 Freezer Series



Orford FML-50 Ice Freezer

RRP \$6920 + GST



Orford Freezer FML-50	3 Door Vertical Ice Display Freezer
Specifications	
Construction	Powder Coated galvanized steel Interior / Exterior White
FML-50	3 DOOR FREEZER
Capacity	1450 Litres (gross)
Dimensions	1880 w x 760 D x 2051 H (mm)
Weight	305 kg (net)
Doors	3 x Self Closing, Triple Glazed Safety Glass, Argon filled with Double Heat reflective Low E,
* Energy Consumption	34.3 kWh/24h/m2
Operating Temp	-18° to -22° C.
Ambient Temp Range	32 degrees
Power Point	220 - 240v 50Hz. (1 x 15 AMP power outlet)
Common Specifications	FML20 / FML30 / FML50
Compressor	Danfoss
Thermometer	Digital Elitech Controller
Shelves per door	4 Height Adjustable Heavy Duty PVC Coated with 1 Fixed Stainless Steel Base shelves
Shelf Adjustment	12mm Increments
Condensate Disposal	Automatic by energy efficient, No Cost, Hot Gas
Footings	Heavy Duty 2.5mm Castors, Lockable Front
Interior Light	LED light
Refrigerant	R404a
Drier	Solid Core
Insulation	60mm Polyurethane, CFC, HCFC, HFC Free
Cabinet Classes	
Condenser Filter	Easy front access
Security	Freezer has lock and key
Drip Tray Evaporation Method	Hot Gas
Kick Panel	Easy unclip and remove system
Defrost	Energy Efficient Hot Gas
Compliance	MEPS, EMC,

Do you have an ABN?
Contact us for a trade discount!





under bench
/bar series



Do you have an ABN?
Contact us for a trade discount!



Alfresco Dining with ORFORD

The Orford Back Bar Cooler Range

The perfect choice for your Alfresco area. The cabinets can be built fully into your cabinet or wall cavity

Energy efficient. Outdoor rated, tested to 32 degrees

The Orford Back Bar Range is part of the Orford

PlanetSmart Range—saving the planet one fridge at a time



Orford BB135	135 Litre Back Bar RRP \$2010 + GST
Construction	Stainless Steel interior & Exterior
Capacity	135 Litres (Gross)
Dimensions	600.W x 500 D + 45mm handle x 865 H
Weight	55 Kg
Operating Temp	0° - 10° C.
Ambient Temp Range	0° - 32° C.
Power Point	220 - 240v 50Hz. (Standard GPO)
Input Current	8.2 Amps
Thermometer	Digital Carel Eco Controller
Shelves	2 Height Adjustable
Door	1 x Low E glass doors with heated door mullion
Fans	EBM fans
Interior Light	LED

Orford BB210	210 Litre Back Bar RRP \$2480 + GST
Construction	Stainless Steel interior & Exterior
Capacity	210 Litres (Gross)
Dimensions	900.W x 500 D + 45mm handle x 865 H
Weight	75 Kg
Operating Temp	0° - 10° C.
Ambient Temp Range	0° - 32° C.
Power Point	220 - 240v 50Hz. (Standard GPO)
Input Current	9.2 Amps
Thermometer	Digital Carel Eco Controller
Shelves	4 Height Adjustable
Door	2 x Low E glass doors with heated door mullion
Fans	EBM fans
Interior Light	LED



Do you have an ABN?
Contact us for a trade discount!



- Body Finish : 304 Stainless
- Interior Finish : Polished 304 Mirror Stainless
- Door Finish : 304 Stainless
- Door Mullion : Heated
- Door Hinged : Self Closing
- Door Opened Depth : 910mm
- Decibel rating : 50
- Double Glazed tempered door. Low E glass
- Can operate in 40 degrees ambient
- Famous parts : Carel Eco controllers, EBM fans, Embraco compressor
- Door Locks

Orford Back Bars Alfresco dining just got better

- Lockable : Yes
- Lighting : LED lights
- Adjustable Feet : Yes (4)
- Shelves : 2 x flat chromed adjustable shelves per door
- MEPS compliant
- CTick compliant
- IP34 Outdoor rated
- Allow 5 - 10 mm Shadowline when building into cabinetry
- Low E Glass Doors



Orford BB325	325 Litre Back Bar RRP \$3465 + GST
Construction	Stainless Steel interior & Exterior
Capacity	325 Litres (Gross)
Dimensions	1350 W x 500 D + 45mm handle x 865 H
Weight	110 Kg
Operating Temp	0° - 10° C.
Ambient Temp Range	0° - 32° C.
Power Point	220 - 240v 50Hz. (Standard GPO)
Input Current	9.2 Amps
Thermometer	Digital Carel Eco Controller
Shelves	6 Height Adjustable
Door	3 x Low E glass doors with heated door mullion
Fans	EBM fans
Interior Light	LED



Do you have an ABN?
Contact us for a trade discount!



Orford Back Bars
Alfresco dining just got
better



Model	H mm	W mm	D mm	Gross Weight KGs	Refrigerant	Shelves	Capacity litres	330ml Bottles	Power Consump- tion (at 25 de- grees ambient)
BB135	865	600	500 +45mm handle	55	R600a	2	135	104	1.93Kwh/24hrs
BB210	865	900	500 + 45mm handle	69	R600a	4	210	169	2.68Kwh/24hrs
BB325	865	1350	500 + 45mm handle	90	R600a	6	325	260	4.22Kwh/24hrs



Door locks standard



ebmpapst

German brand EBM fan
motors for reliable service



Do you have an ABN?
Contact us for a trade discount!



Halo SB6—1G (800mm)	110 Ltr Back Bar RRP \$3050 + GST
Construction	Colorbond
Capacity	110 Litre
Dimensions	660 mm w x 550 mm d x 800 mm h
Weight	55kg
Operating Temp	1 degree ~ 8 degrees
Ambient Temp Range	28 degrees—in air conditioned premises
Power Point	10 Amp plug
Power	2.5 AMPS / 240V / 50Hz 190 Watts
Thermometer	Digital controller
Shelves	1 shelves
Refrigerant	R-134a
Doors	1 x self closing
Lighting	Internal LED

Halo SB9—2G (800mm)	165 Ltr Back Bar \$3850 + GST
Construction	Colorbond
Capacity	165 Litre
Dimensions	900 mm w x 550 mm d x 800 mm h
Weight	75kg
Operating Temp	1 degree ~ 8 degree
Ambient Temp Range	28 degrees—in air conditioned premises
Power Point	10 AMP plug
Power	2.5 Amps / 240V / 50 Hz 190 Watts
Thermometer	Digital controller
Shelves	2 shelves
Refrigerant	R 134a
Doors	2 x self closing
Lighting	Internal LED



Halo SB13—3G (800mm)	261 Ltr Back Bar \$4740 + GST
Construction	Colorbond
Capacity	261 Litre
Dimensions	1352 mm w x 550 mm d x 800 mm h
Weight	100 kg
Operating Temp	1 degree ~ 8 degree
Ambient Temp Range	28 degrees—in air conditioned premises
Power Point	10 AMP plug
Power	3.5 Amps / 240V / 50 Hz 330 Watts
Thermometer	Digital controller
Shelves	3 shelves
Refrigerant	R 134a
Doors	2 x self closing
Lighting	Internal LED



Halo KUR Refrigerator

Do you have an ABN?
Contact us for a trade discount!



Halo KUR9-1	198 Litre Underbench RRP \$3115 + GST
Construction	Stainless Steel interior & Exterior
Capacity	198 Litres (Gross)
Dimensions	900 W x 700 D x 850 mm H (on castors)
Weight	72 Kg
Operating Temp	0° - 10° C.
Ambient Temp Range	0° - 32° C.
Power Point	220 - 240v 50Hz. (Standard GPO) 1 x 10AMP plug
Input Current	3 Amps
Thermometer	LED Digital Display Soft Touch Controller
Shelves	1 Height Adjustable
Refrigerant	R134a
Compressor	Left hand side Embraco Compressor

Halo KUR12-2

311 Litre Underbench RRP \$3415 + GST

Construction	Stainless Steel interior & Exterior
Capacity	311 Litres (Gross)
Dimensions	1200 W x 700 D x 850 mm H (on castors)
Weight	84 Kg
Operating Temp	0° - 10° C.
Ambient Temp Range	0° - 32° C.
Power Point	220 - 240v 50Hz. (Standard GPO) 1 x 10AMP plug
Input Current	3 Amps
Thermometer	LED Digital Display Soft Touch Controller
Shelves	2 x Height Adjustable
Refrigerant	R134a
Compressor	Left hand side Embraco Compressor



Halo KUR15-2

425 Litre Underbench RRP \$3900 + GST

Construction	Stainless Steel interior & Exterior
Capacity	425 Litres (Gross)
Dimensions	1500 W x 700 D x 850 mm H (on castors)
Weight	93 Kg
Operating Temp	0° - 10° C.
Ambient Temp Range	0° - 32° C.
Power Point	220 - 240v 50Hz. (Standard GPO) 1 x 10AMP plug
Input Current	3 Amps
Thermometer	LED Digital Display Soft Touch Controller
Shelves	3 x Height Adjustable
Refrigerant	R134a
Compressor	Left hand side Embraco Compressor

Halo KUR19-3

538 Litre Underbench RRP \$4200 + GST

Construction	Stainless Steel interior & Exterior
Capacity	538 Litres (Gross)
Dimensions	1800 W x 700 D x 850 mm H (on castors)
Weight	109 Kg
Operating Temp	0° - 10° C.
Ambient Temp Range	0° - 32° C.
Power Point	220 - 240v 50Hz. (Standard GPO) 1 x 10AMP plug
Input Current	4.4 Amps
Thermometer	LED Digital Display Soft Touch Controller
Shelves	3 x Height Adjustable
Refrigerant	R134a
Compressor	Left hand side Embraco Compressor



Orford
REFRIGERATION



Do you have an ABN?
Contact us for a trade discount!

<i>Halo KUR18-3 Undercounter Specifications</i>	Horizontal Undercounter Fridge \$4200 + GST
Construction	Stainless steel exterior & interior
Capacity	538 Litre
Dimensions	1800 w x 700 d x 850 h (mm) on castors
Weight	109 kg
Operating Temp	0c to 8c,
Ambient Temp Range	Up to 32 degrees
Input Current	220V / 50Hz
Thermometer	LED Digital Display & Soft Touch Control
Shelves	3 shelves
Refrigerant	R134a
Compressor	Embraco
Fans	EBM fans



<i>Halo KUR24-4 Undercounter Specifications</i>	Horizontal Undercounter Fridge \$5400 + GST
Construction	Stainless steel exterior & interior
Capacity	640 Litre
Dimensions	2440 w x 700 d x 850 h (mm) on castors
Weight	122kg
Operating Temp	0c to 8c,
Ambient Temp Range	Up to 32 degrees
Input Current	220V / 50Hz 10 AMP
Thermometer	LED Digital Display & Soft Touch Control
Shelves	4 shelves
Refrigerant	R134a
Compressor	Embraco
Fans	EBM fans



Do you have an ABN?
Contact us for a trade discount!



Halo KUF 9-1	198 Lt Undercounter FREEZER \$3375 + GST
Construction	All stainless steel 304 with left sided Embraco Compressor
Capacity	198 ltr
Dimensions	900 w x 700 d x 850 h (mm) On castors
Weight	72 kg
Operating Temp	- 21c to—12c degrees
Ambient Temp Range	32 degrees
Power Point	10 Amp plug
Input Current	500 w
Thermometer	LED digital Display & Solft touch controller
Shelves	1 shelf

Halo KUF 12-2	311 Lt Undercounter FREEZER \$3710 + GST
Construction	All stainless steel 304 with left sided Embraco Compressor
Capacity	311 ltr
Dimensions	1200 w x 700 d x 850 h (mm) On castors
Weight	84 kg
Operating Temp	- 21c to—12c degrees
Ambient Temp Range	32 degrees
Power Point	10 Amp plug
Input Current	366 w
Thermometer	LED digital Display & Solft touch controller
Shelves	2 shelf



Halo KUF 15-2	425 Lt Undercounter FREEZER \$4100 + GST
Construction	All stainless steel 304 with left sided Embraco Compressor
Capacity	425 ltr
Dimensions	1500 w x 700 d x 850 h (mm) On castors
Weight	87 kg
Operating Temp	- 21c to—12c degrees
Ambient Temp Range	32 degrees
Power Point	10 Amp plug
Input Current	366 w
Thermometer	LED digital Display & Solft touch controller
Shelves	2 shelf
Refrigerant	R404a



Halo KUF 18-3	538 Lt Undercounter FREEZER \$4800 + GST
Construction	All stainless steel 304 with left sided Embraco Compressor
Capacity	538 ltr
Dimensions	1800 w x 700 d x 850 h (mm) On castors
Weight	109 kg
Operating Temp	- 21c to—12c degrees
Ambient Temp Range	32 degrees
Power Point	10 Amp plug
Input Current	613 w 4.4 Amps
Thermometer	LED digital Display & Solft touch controller
Shelves	3 shelf
Refrigerant	R404a



Do you have an ABN?
Contact us for a trade discount!

Halo KURF12-2	Undercounter FREEZER / FRIDGE \$5000 + GST
Construction	All stainless steel 304 with left sided Embraco Compressor
Capacity	Freezer 134 Ltr / Fridge 136 ltr
Dimensions	1200 w x 700 d x 850 h (mm) On castors
Weight	87 kg
Operating Temp	Fridge 1—5 degrees / Freezer 21c to—12c degrees
Ambient Temp Range	32 degrees
Power Point	10 Amp plug
Input Current	316 w
Thermometer	LED digital Display & Solft touch controller
Shelves	2 shelf
Refrigerant	Freezer R404a / Fridge r134a



Halo KURF15-2	Undercounter FREEZER / FRIDGE \$5200 + GST
Construction	All stainless steel 304 with left sided Embraco Compressor
Capacity	Freezer 177 Ltr / Fridge 189 ltr
Dimensions	1500 w x 700 d x 850 h (mm) On castors
Weight	96 kg
Operating Temp	Fridge 1—5 degrees / Freezer 21c to—12c degrees
Ambient Temp Range	32 degrees
Power Point	10 Amp plug
Input Current	316 w
Thermometer	LED digital Display & Solft touch controller
Shelves	2 shelf
Refrigerant	Freezer R404a / Fridge r134a



Halo KURF18-3	Undercounter FREEZER / FRIDGE \$5400 + GST
Construction	All stainless steel 304 with left sided Embraco Compressor
Capacity	Freezer 151 Ltr / Fridge 314 ltr
Dimensions	1800 w x 700 d x 850 h (mm) On castors
Weight	96 kg
Operating Temp	Fridge 1—5 degrees / Freezer 21c to—12c degrees
Ambient Temp Range	32 degrees
Power Point	10 Amp plug
Input Current	316 w
Thermometer	LED digital Display & Solft touch controller
Shelves	2 shelf
Refrigerant	Freezer R404a / Fridge r134a



Do you have an ABN?
Contact us for a trade discount!

<i>Halo KGR9—1 door</i>	Horizontal Undercounter Fridge \$3254 + GST
Specifications	
Capacity	137 Litre
Dimensions	900 w x 700 d x 850 h (mm) on castors
Weight	80 kg on castors
Operating Temp	0c to 8c,
Ambient Temp Range	Up to 28 degrees
Input Current	220V / 50Hz 10 AMP
Thermometer	LED Digital Display & Soft Touch Control
Doors & Shelves	1 door with LOW E glass and 1 shelf
Refrigerant	R134a



<i>Halo KGR12—2 door</i>	Horizontal Undercounter Fridge \$ 4350 + GST
Specifications	
Capacity	311 Litre
Dimensions	1200 w x 700 d x 850 h (mm) on castors
Weight	80 kg on castors
Operating Temp	0c to 8c,
Temp Range	Up to 28 degrees ambient
Input Current	220V / 50Hz 10 AMP
Thermometer	LED Digital Display & Soft Touch Control
Doors & Shelves	2 doors with LOW E glass and 2 shelves
Refrigerant	R134a



Do you have an ABN?
Contact us for a trade discount!

<i>Halo KGR15—2 door</i> Specifications	Horizontal Undercounter Fridge \$4550 + GST
Capacity	425 Litre
Dimensions	1500 w x 700 d x 850 h (mm) on castors
Weight	90 kg on castors
Operating Temp	0c to 8c,
Ambient Temp Range	Up to 28 degrees
Input Current	220V / 50Hz 10 AMP
Thermometer	LED Digital Display & Soft Touch Control
Doors & Shelves	2 door with LOW E glass and 2 shelf
Refrigerant	R134a



<i>Halo KGR18—3 dr</i> Specifications	Horizontal Undercounter Fridge \$5455 + GST
Capacity	538 Litre
Dimensions	1800 w x 700 d x 850 h (mm) on castors
Weight	127 kg on castors
Operating Temp	0c to 8c,
Temp Range	Up to 28 degrees ambient
Input Current	220V / 50Hz 10 AMP
Thermometer	LED Digital Display & Soft Touch Control
Doors & Shelves	3 door with LOW E glass and 3 shelves
Refrigerant	R134a



food
service



halo®

KRF Combos

Do you have an ABN?
Contact us for a trade discount!

Halo KRF 25-2	664 Litre Combo RRP \$5290 + GST
Construction	Stainless Steel interior & Exterior top Mount
Capacity	Freezer 242 Litres plus Fridge 222 Litres = 664 Ltre
Dimensions	640 W x 800 D x 1926 mm H (on castors)
Weight	150 Kg
Operating Temp	Fridge—1° - 10° C. Freezer - 21° - 12° C.
Ambient Temp Range	0° - 32° C.
Power Point	220 - 240v 50Hz. (Standard GPO) 1 x 10AMP plug
Input Current	4.4 Amps
Thermometer	LED Digital Display Soft Touch Controller
Shelves	2 x Height Adjustable
Refrigerant	R134a & R404a (freezer)
Compressor	Two compressor system

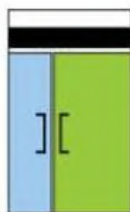
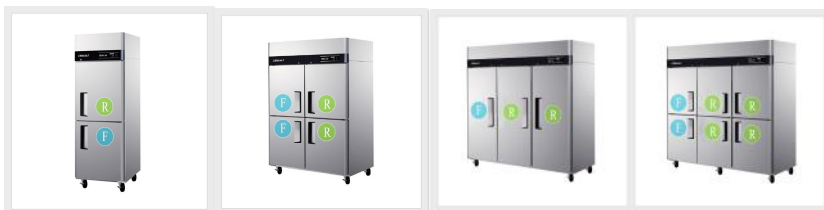

Halo KRF 45-2	1109 Litre Combo RRP \$7335+ GST
Construction	Stainless Steel interior & Exterior top Mount
Capacity	Freezer 464 Litres plus Fridge 645 Litres = 1109 Ltre
Dimensions	1260 W x 800 D x 1926 mm H (on castors)
Weight	150 Kg
Operating Temp	Fridge—1° - 10° C. Freezer - 21° - 12° C.
Ambient Temp Range	0° - 32° C.
Power Point	220 - 240v 50Hz. (Standard GPO) 1 x 15 AMP plug
Input Current	Fridge - 4.4 Amps Freezer—6.73 Amps 15amp
Thermometer	LED Digital Display Soft Touch Controller
Shelves	2 x Height Adjustable
Refrigerant	R134a (fridge) & r404a (freezer)
Compressor	Two compressor system

Orford
REFRIGERATION



Do you have an ABN?
Contact us for a trade discount!

Halo KRF 45-4	Dual Temp Fridge / Freezer RRP \$7860 + GST
Construction	Stainless Steel Top Mount
Capacity	Freezer 464 litres / fridge 642 litres = 1106 litres
Dimensions	1260 w x 800 d x 1935 h (including castors)
Weight	150 kg
Operating Temp	Fridge 2c to 6c Freezer— -21c to -12c
Ambient Temp Range	Temp—Fridge 2c to 6c Freezer— -21c to -12c
Power Point	15 Amp Australian plug
Input Current	Fridge—R-134A 4.4amps power—w673,
Thermometer	Digital
Shelves	3 per side (6 in total)
Refrigerant	R134a and R404a
Compressor	Two compressor system



Halo KRF 65-3	Dual Temp Fridge / Freezer RRP \$9,015 + GST
Construction	Stainless Steel Top Mount
Capacity	Freezer 555 litres / fridge 1275 litres = 1830 litres
Dimensions	1900 w x 800 d x 1935 h (including castors)
Weight	250 kg
Operating Temp	Fridge 2c to 6c Freezer— -21c to -12c
Ambient Temp Range	Temp—Fridge 2c to 6c Freezer— -21c to -12c
Power Point	15 Amp Australian plug
Input Current	Fridge—R-134A 4.4amps power—w673,
Thermometer	Digital
Shelves	3 per door (9 in total)
Refrigerant	R134a and R404a
Compressor	Two compressor system

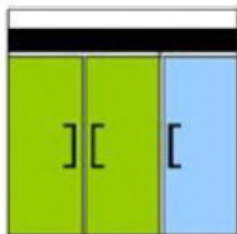

Do you have an ABN?
Contact us for a trade discount!



Model	Temp	Doors	Net Volume	Shelves	Dimensions	Power 220v 50Hz	Shipping Weight
Halo KR25-1	Refrigerator 1~ 8 degrees	1	574	3	640w x 850d x 1926h	314w	115
Halo KF25-1	Freezer -21 ~ -12 degrees	1	574	3	640w x 850d x 1926h	496w	120
Halo KR45-2	Refrigerator 1 ~ 8 degrees	2	1215	6	1260w x 850d x 1926h	366w	190
Halo KF45-2	Freezer -21~ -12 degrees	2	1215	6	1260w x 850d x 1926h	774w	200
Halo KR65-3	Refrigerator 1—8 degrees	3	1876	9	1900w x 850d x 1926h	732w	280
Halo KF65-3	Freezer -21 ~ 12 degrees	3	1876	9	1900w x 850d x 1926h	1346w	280

Note : the depth includes 50mm for the rear condensate tray

Do you have an ABN?
Contact us for a trade discount!

Orford
REFRIGERATION



The K Series Features

- Designed to 40 Degrees ambient operating temperature
- Requires one standard power point : - 240V 50Hz 10 amp
- Digital Temperature Display
- 3 height adjustable shelves per door. Individual shelves behind each door maximize storage configurations
- Stainless steel construction for superior corrosion resistance
- Stainless steel internal floor with coved corners allows for easy cleaning and sanitizing
- Large castors for ease of cabinet movement
- Solid lockable doors. Designed with recessed handle and self closing hinging with 90 degree dwell feature
- LED interior lighting
- One piece door gaskets, removable without tools for easy cleaning
- Automatic energy efficient hot gas condensate disposal. No drainage required
- Internal Pressure release valve



Do you have an ABN?
Contact us for a trade discount!



Halo KR25-1	574 Ltr Refrigerator RRP \$3795 + GST
Construction	Stainless Steel Top Mount
Capacity	574 Litre
Dimensions	640 w x 850 d x 1926 h (incl castors)
Weight	80kg
Operating Temp	1c to 8c
Ambient Temp Range	32 degrees ambient
Power Point	10 Amp
Input Current	Refrigerant R-134a Amps 3.5 Power - W366
Thermometer	Digital
Shelves	3 adjustable
Refrigerant	R134a

Halo KR45—2	1215 Ltr Refrigerator RRP \$5105 + GST
Construction	Stainless Steel Top Mount
Capacity	1215 Litre
Dimensions	1130 w x 850 d x 1926 h (incl castors)
Weight	80kg
Operating Temp	1c to 8c
Ambient Temp Range	32 degrees ambient
Power Point	10 Amp
Input Current	Refrigerant R-134a Amps 3.5 Power - W366
Thermometer	Digital
Shelves	4 adjustable
Refrigerant	R134a



Halo KR65—3	1876 Ltr Refrigerator RRP \$7670 + GST
Construction	Stainless Steel Top Mount
Capacity	1876 Litre
Dimensions	1900 w x 850 d x 1926 h (incl castors)
Weight	167 kg
Operating Temp	1c to 8c
Ambient Temp Range	32 degrees ambient
Power Point	10 Amp
Input Current	Refrigerant R-134a Amps 3.5 Power - W366
Thermometer	Digital
Shelves	6 adjustable
Refrigerant	R134a





halo®

KF Freezer

Do you have an ABN?
Contact us for a trade discount!



Halo KF25-1F	574 ltr Freezer RRP \$4250 + GST	
Construction	Stainless steel inner & outer Top Mount	
Capacity	574 litre	
Dimensions	640 w x 850 d x 1926 h (including castors)	
Weight	80 kg	
Operating Temp	-12c to -25c	
Ambient Temp Range	36 degrees ambient	
Power Point	10 Amps	
Input Current	Power - W496	10 Amp
Thermometer	Digital	
Shelves	3 adjustable	
Refrigerant	R-404a	

Halo KF45-2F	1215 ltr Freezer RRP \$6495 + GST	
Construction	Stainless steel inner & outer Top Mount	
Capacity	1215 litre	
Dimensions	1260 w x 850 d x 1926 h (including castors)	
Weight	142 kg	
Operating Temp	-12c to -25c	
Ambient Temp Range	36 degrees ambient	
Power Point	10 Amps	
Input Current	Power - W496	10 Amp
Thermometer	Digital	
Shelves	6 adjustable	
Refrigerant	R-404a	



Halo KF65-3F	1876 ltr Freezer RRP \$9290 + GST	
Construction	Stainless steel inner & outer Top Mount	
Capacity	1876 litre	
Dimensions	1900 w x 850 d x 1926 h (including castors)	
Weight	167 kg	
Operating Temp	-12c to -25c	
Ambient Temp Range	36 degrees ambient	
Power Point	15 Amps	
Input Current	Power - W496	15 Amp
Thermometer	Digital	
Shelves	9 adjustable	
Refrigerant	R-404a	

Orford
REFRIGERATION





halo®

KF Glass Freezer

Halo KF25-1G	574 ltr Freezer with Glass RRP \$5295 + GST
Construction	Stainless steel inner & outer Top Mount with glass door
Capacity	574 litre
Dimensions	640 w x 850 d x 1926 h (including castors)
Weight	95 kg
Operating Temp	-12c to -25c
Ambient Temp Range	36 degrees ambient
Power Point	10 Amps
Input Current	Power - W496 10 Amp
Thermometer	Digital
Shelves	3 adjustable
Refrigerant	R-404a



Halo KF45-2G	1215 ltr Freezer with Glass RRP \$8865 + GST
Construction	Stainless steel inner & outer Top Mount with glass door
Capacity	1215 litre
Dimensions	1260 w x 850 d x 1926 h (including castors)
Weight	170 kg
Operating Temp	-12c to -25c
Ambient Temp Range	36 degrees ambient
Power Point	10 Amps
Input Current	Power - W496 10 Amp
Thermometer	Digital
Shelves	6 adjustable
Refrigerant	R-404a

Do you have an ABN?
Contact us for a trade discount!



Do you have an ABN?
Contact us for a trade discount!

Halo 20 Auto CB— Refrigerated Premix dispenser

RRP \$980 + GST

The Halo 20 Auto CB is a dual pour chilled beverage dispenser ideal for storing, chilling and dispensing beverage and is built to withstand the demands of high traffic areas such as Hotels, Resorts, Clubs, Pubs, Cafeterias, etc

Operates at +2 degrees to + 10 at 30 degrees ambient temp and 60% humidity

Features

- stores two x 10Lt packages of beverage simultaneously
- Light box display
- Electronic control system. The millilitres dispensed can be controlled
- Strong durable colorbond metal liner easy to clean and is rust resistant
- The outlet pipeline is surrounded by a shield
- A removable partition can be adjusted accommodate cups at different heights
- Dual pour



<i>Halo 20 Auto</i>	Refrigerated Premix Dispenser
Construction	Power coated galvanised steel—white
Capacity	20Lt 2 x 10Lt Milk bladders
Dimensions	386 w x 572 d x 901 h (mm)
Weight	35kg
Operating Temp	0 to 10 degrees
Ambient Temp Range	0 to 30 degrees
Power Point	220—240 v 50Hz (Standard GPO)
Pouring Control System	Electronic Control system with controlled milk pourer
Controller	Mechanical
Switches	Refrigeration switch and lamp switch are separate
Energy Consumption	0.85 kWh / 24hrs
Refrigerant	R134a



Do you have an ABN?
Contact us for a trade discount!



Halo KHR9-1 Specifications

Salad Table with Hood Lid RRP \$3650 + GST

Construction	Stainless Steel
Capacity	213 Litres
Dimensions	900 w x 700 d x 1134 h (with castors)
Weight	100 kg
Operating Temp	0° - 5° C.
Ambient Temp Range	0° - 32° C.
Power Point	220 - 240v 50Hz. (Standard GPO)
Input Current	2.5 Amps
Condiment Pans	1/6 size pans, 100mm deep plastic condiment pans
Shelves	1 shelf per door
Cutting Boards	204 mm deep, 12 mm thick cutting board
Temperature Controller	Digital Controller
Air Curtin	Cold air curtin forcing air to flow around the food pan area, covering underneath the pan and front, top and rear
Doors	1 Door with Door locks standard
Refrigerant	R134a

Halo KHR12-2 Specifications

Salad Table with Hood Lid RRP \$4350 + GST

Construction	Stainless Steel
Capacity	309 Litres
Dimensions	1200 w x 700 d x 1134 h (with castors)
Weight	100 kg
Operating Temp	0° - 5° C.
Ambient Temp Range	0° - 32° C.
Power Point	220 - 240v 50Hz. (Standard GPO)
Input Current	3 Amps
Power	314 W
Condiment Pans	1/6 size pans, 100mm deep plastic condiment pans
Shelves	1 shelf per door
Cutting Boards	204 mm deep, 12 mm thick cutting board
Temperature Controller	Digital Controller
Air Curtin	Cold air curtin forcing air to flow around the food pan area, covering underneath the pan and front, top and rear
Doors	2 Doors with Door locks standard
Refrigerant	R134a



Do you have an ABN?
Contact us for a trade discount!

<i>Halo KHR15-2</i>	Salad Table with Hood Lid RRP \$4800 + GST
Specifications	
Construction	Stainless Steel
Capacity	420 Litres
Dimensions	1500 w x 700 d x 1134 h (with castors)
Weight	100 kg
Operating Temp	0° - 5° C.
Ambient Temp Range	0° - 32° C.
Power Point	220 - 240v 50Hz. (Standard GPO)
Input Current	3 Amps
Power	314 W
Condiment Pans	1/6 size pans, 100mm deep plastic condiment pans
Shelves	1 shelf per door
Cutting Boards	204 mm deep, 12 mm thick cutting board
Temperature Controller	Digital Controller
Air Curtin	Cold air curtin forcing air to flow around the food pan area, covering underneath the pan and front, top and rear
Doors	2 Doors with Door locks standard
Refrigerant	R134a



<i>Halo KHR18-3</i>	Salad Table with Hood Lid RRP \$6200 + GST
Specifications	
Construction	Stainless Steel
Capacity	516 Litres
Dimensions	1800 w x 700 d x 1134 h (with castors)
Weight	102 kg
Operating Temp	0° - 5° C.
Ambient Temp Range	0° - 32° C.
Power Point	220 - 240v 50Hz. (Standard GPO)
Input Current	4.4 Amps
Power	366 W
Condiment Pans	1/6 size pans, 100mm deep plastic condiment pans
Shelves	1 shelf per door
Cutting Boards	204 mm deep, 12 mm thick cutting board
Temperature Controller	Digital Controller
Air Curtin	Cold air curtin forcing air to flow around the food pan area, covering underneath the pan and front, top and rear
Doors	3 Doors with Door locks standard
Refrigerant	R134a

ice machines

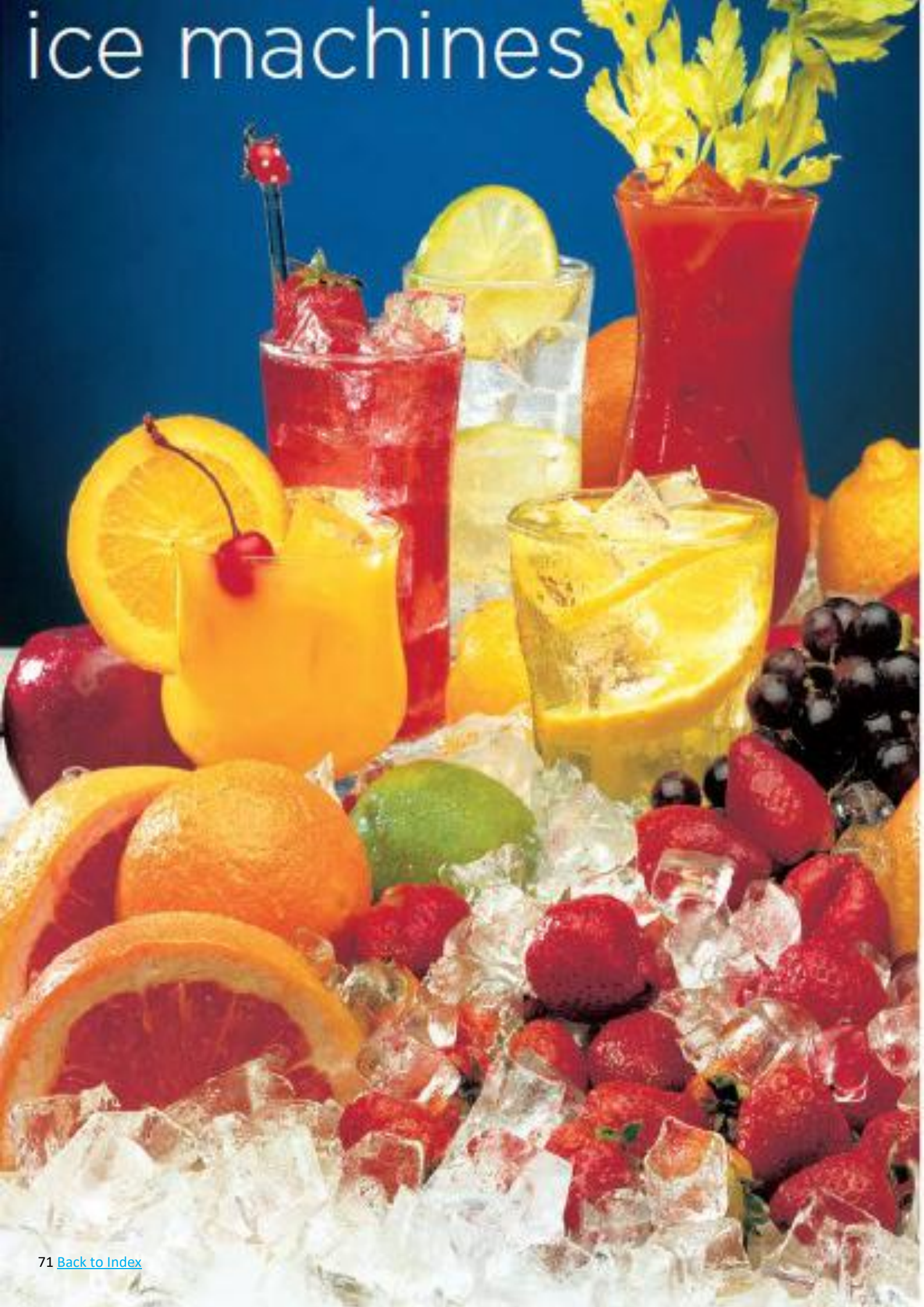

HALF DICE



Hard, clear ice cube with unique "rhomboid" shape 3/8" x 1-1/8" x 7/8" (0.95 x 2.86 x 2.22 cm) in dimension, 96 cubes per pound of ice, maximum cooling with nearly 100% ice to water ratio.

DICE



Hard, clear ice cube with unique "rhomboid" shape 7/8" x 7/8" x 7/8" (2.22 x 2.22 x 2.22 cm) in dimension, 48 cubes per pound of ice, maximum cooling with nearly 100% ice to water ratio.

REGULAR



Hard, clear ice cube with unique "rhomboid" shape 1-1/8" x 1-1/8" x 7/8" (2.86 x 2.86 x 2.22 cm) in dimension, 32 cubes per pound of ice, maximum cooling with nearly 100% ice to water ratio.

GOURMET



Hard, clear, individual ice cube with unique octagon shape 1-3/8" x 1-3/8" (3.49 x 3.49 cm) in dimension, maximum cooling with nearly 100% ice to water ratio.



NUGGET



Easy to chew but hard enough to be dispensed without hand scooping, 3/8" (.95 cm) to 1/2" (1.27 cm) in width and length on average.

TUBULAR NUGGET



Softer texture with good cooling. Cylindrical shaped nugget with 5/8" (1.59 cm) diameter and average length of 1" (2.54 cm) with 90% ice to water ratio.

FLAKE



Small, soft pieces of ice with a 73% ice to water ratio. Perfect for displaying products and hand scooping into drinks.

CRUSHED



Manitowoc dice or half dice cubes crushed into small pieces using a Manitowoc ice machine and a Servend® beverage dispenser equipped with icepic™ ice crusher.



Manitowoc Ice Machines

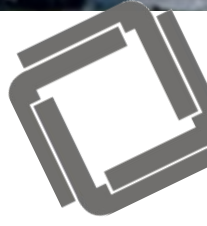

SOTTO
The clear and simple choice.

Manitowoc

Model	21 Air / 10 Water	32 Air / 21 Water	Storage Capacity	Dimensions H x W x D cm	RRP ex GST
UG30	31kg	25kg	10KG	65 X 45 X 57.5	2950
UG50	57kg	43KG	25KG	80 X 55 X 55	3690
UG65	65kg	58KG	44KG	90 X 70 X 60	4060
UG80	85kg	67KG	44KG	90 X 70 X 60	4390
Levellers supplied with all models (adjustable)					
Optional adjustable Legs (set of 4)	K00345001	10.1—15.2	200		

24 HOUR Production

Octagonal Gourmet Ice Cubes

All units 10amp Power

Uses gravity to drain water away

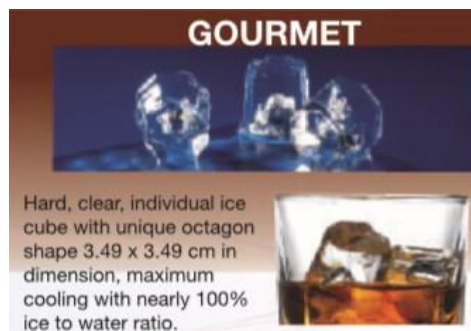

UG80



Manitowoc Undercounter Cubers

NEO

The everywhere you need ice machine.

Manitowoc

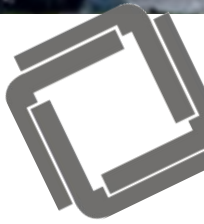

Model	21 air / 10 water	32 air / 21 water	Storage Capacity	Dimensions H x W x D cm	RRP Price Ex GST
U080—Full dice	40KG	28KG	14KG	91.4 X 50 X 56.7	4160
NEO-u140	55KG	41KG	40KG	97.8 X 66 X 71.1	5320
NEO-u190	79KG	60KG	36KG	97.8 X 66 X 71.1	5530
NEO-u240	87KG	68KG	36KG	97.8 X 66 X 71.1	5830
NEO-u310	132KG	103KG	45KG	97.8 X 76.2 X 71.5	7420
LEGS X 4 K00445	30MM			Optional	120

Standard legs supplied—Adjustable 15.24—20.33 All units 10Amp power with 2.43 mt Lead
Neo models available in full and half dice at the same price

Specs quoted are all Full dice. Half dice available. Please ask.

The U080 replaces the QM45



1300 673 673



INDIGO | Intelligent thinking inside the box.



24Hr production. Full and Half cubes available.

Only Full dice quoted below. Please phone or email for other models.

Model	21 Air / 10 water	32 Air / 21 water	Dimensions (ex bin)	RRP exc GST
Modular Width			H x W x D cm	
I-322 Full Dice (ID0322a)	146kg	98kg	55 x 55.9 x 62	7240
i-522 Full Dice (ID0522a)	207kg	150kg	55 x 55.9 x 62	7580
I-522 Half Dice (IY0524a)	211kg	162kg		7580

Bin models to suit

i-322 : A320, A420 or A570* (*requires adapter plate K00472 RRP \$470 + GST)

i-522 : A320, A420 or A570** (**requires adapter plate K00470 RRP \$790 + GST)

Model	Storage Capacity	Dimensions	RRP exc GST
A320	95KG	96.5 X 55.9 X 86.4	1910
A420	141KG	127 X 55.9 X 86.4	2110
A570	195KG	127 X 76.2 X 86.4	2380

Standard legs supplied with bins—Adjustable 15.24—20.33

All units suit 10 Amp Australian plugs



1300 673 673



Indigo Series I-522 Ice Machine on B-420 Bin



INDIGO | Intelligent thinking inside the box.

24Hr production. Full and Half cubes available.

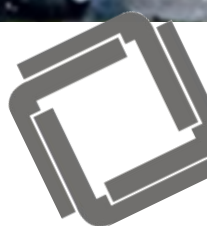

Model	21 Air / 10 water	32 Air / 21 water	Dimensions	RRP exc GST
Regular Width			H x W x D cm	
i-450—Full dice (ID0452a)	183KG	139KG	55 X 76.2 X 63	7720
i-606—Full dice (ID0606a)	253KG	185KG	55 X 76.2 X 63	9290
i-606—Half dice (IY0606a)	277kg	261kg		
i-906—Full dice (ID0906a)	381KG	289KG	68 X 76.2 X 63	12100
i-906—Half dice (IY0906a)	409kg	309kg		
i-1106—Full dice (ID1106a)	497KG	368KG	68 X 76.2 X 63	13900
i-1106—Half dice (IY1106a)	523kg	379kg		

I450 & I606 10Amp power / I906 & I1106 15 Amp power 1.83mt Lead

Bin models to suit

Adaptor Plate for i-322, i-522
on A400v, A570V bin

K00472 (K00365) \$400 + GST

Adaptor platefor i-450—
i1106 on A970v Bin

K00470 (K00458) \$670 + GST

Model	Storage Capacity	Dimensions	RRP exc GST
A400	132kg	96.5 x 76.2 x 86.4	2090
A570	195kg	127 x 76.2 x 86.4	2380
A970	322kg	127 x 121.9 x 86.4	3390



1300 673 673





Manitowoc Ice Machines

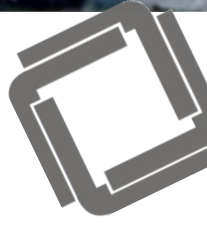

INDIGO | Intelligent thinking inside the box.



Indigo Series I-1400 Ice Machine on B-970 Bin



INDIGO



S-3070C Ice Machine - 115V



Indigo NXT Series iT1900 Ice Machine on D970 Bin



CVD Condensing Unit - 208-230/60/3



INDIGO | Intelligent thinking inside the box.

24Hr production. Full and Half cubes available.

Only Full dice quoted below. Please phone or email for other models.

Model	21 Air / 10 water	32 Air / 21 water	Dimensions	RRP exc GST
The Wide Boys				
H x W x D cm				
i-1400 (ID1406a)	653kg	503kg	194.3 x 121.9 x 86.4	\$15,670
i-1800 (IY1804A)	810kg	634kg	201.9 x 121.9 x 86.3	\$17,200
NXT i-1900	816kg	612 kg	201.9 x 121..9 x 86.4	\$21,810

Bin models to suit

I400-I800 : A970 or F1300

S3070 : F1300

Model	Storage Capacity	Dimensions	RRP exc GST
A970	322kg	127 x 121.9 x 86.4	3390
F1300	599kg	161.3 x 121.9 x 78.7	10,150

Adaptor Plates

A570 bin uses K00472 (K00365) adaptor—RRP \$470+ GST

A970 bin uses K00470 (K00458) adaptor—RRP \$790 + GST



1300 673 673



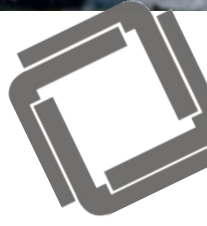

Flakers



RF0385A



RF0266A



RF0644A



RFS300A
Bin A420



RFS650A
Bin A420



RFS1200
A570 bin



RF2300
Bin F1300





Flakers

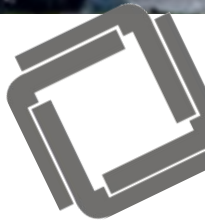

Under Counter Flakers—Head and Bin

Model	21 Air / 10 water	32 Air / 21 water	Storage Capacity	Dimensions H x W x D cm	RRP exc GST
RF0266A	77kg	63kg	27kg	95 x 50 x 66	\$8,080
RF0385A	152kg	122kg	40kg	101 x 74 x 69	\$8,500
RF0644A	312kg	231kg	54kg	117 x 74 x 68	\$11,100

Modular Flakers—Head Only

Model	21 Air / 10 water	32 Air / 21 water	Dimensions	RRP exc GST
RFS300A	174kg	130kg	66 x 56 x 60	\$8,380
RFS650A	305kg	248kg	66 x 56 x 60	\$10,740
RFS1200	545kg	396kg	70 x 64 x 47	\$14,500
RFS2378C	984kg	772kg	70 x 76 x 60	\$25,030

Bin to Suit

RFS300A : A320, A430, A570*

RFS1200 : A570V* A970V**

RFS650 : A420, A570*

RF2300 : F1300

*Requires adapter plate K00472

**requires adaptor plate K00470

Model	Storage Capacity	Dimensions H x W x D cm	RRP exc GST
A320	95kg	97 x 56 x 86	\$1910
A420	141kg	127 x 56 x 86	\$2110
A570*	195kg	127 x 76 x 86	\$2380
A970	322kg	127 x 122 x 86	\$3390
F1300	600kg	162 x 122 x 79	\$10,150
*K-00472		Adaptor plate	470
K-00470		Adaptor plate	790

 **1300 673 673**



Dispensers

Modular Dispensers—Order Ice Maker Separately



Model	Storage Only	Dimensions—Dispenser Only H x W x D cm	RRP exc GST
SPA160 - Ice Dispenser	54kg	122 x 56 x 80	\$9,210
SFA291—Ice & Water Dispenser	82kg	139 x 76 x 82	\$12,240
SPA310—Ice Dispenser	82KG	138 X 76 X 82	\$11,030
DISP500T	294kg	186 x 76 x 134	\$26,200
DISP1000T	490kg	181 x 122 x 134	\$33,200



SFA Ice Dispenser comes with bin inclusive of water valve

- SPA Ice Only Dispenser
- SFA Ice & Water Dispenser
- SN12A 10 Amp Power
- SFA & APS Units 10 Amp Power
- T Timed Agitation



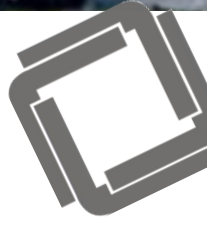

A320



A400



A420



A570



A970



F1300



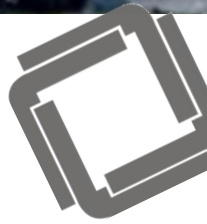

Model	Storage Only	Dimensions—Dispenser Only		RRP exc GST
		H x W x D cm		
A320	95kg	97 x 56 x 86		\$1910
A400	132kg	97 x 76 x 86		\$2090
A420	141kg	127 x 56 x 86		\$2110
A570	195kg	127 x 76 x 86		\$2380
K-00472 (K00365)	Adaptor Plate for i-322, i-522 on A400, A570 bin			\$470
A970	322kg	127 x 122 x 86		\$3390
K-00470 (K00458)	Adaptor Plate for i-450—i1200 on A970 Bin			\$790
F1300	600kg	162 x 122 x 79		\$10,150
F1325	601kg	1368 x 152 x 79		\$10,410
K420	141kg	127 x 76 x 86		\$1680
K570	195kg	127 x 76 x 86		\$1910

Standard adjustable legs supplied with all models 15.24—20.33





Nugget Machines



RNS 12A
Countertop Nugget
Machine



RNS0608A—Nugget Head
Bin sold separately



RNS0244A—Nugget Ice Machine



RNS0308—Nugget Head
Bin sold separately



RNS0385 Nugget ice machine





Nugget Machines

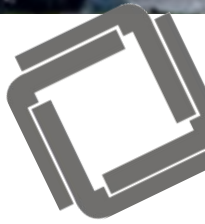

Model	24 hour Production		Dimensions— Dispenser Only H x W x D cm	RRP exc GST
	Air °C / Water °C			
	21 / 10	32 / 21		
RNS 12A—countertop Nugget Machine	118kg - 84kg		89 x 41.3 x 61	\$11,480
RNS 20A—countertop Nugget Machine	118kg - 84kg		107 x 413 x 61	\$13,810
RNS0244A—Nugget head & Bin	Bin storage 18kg	78kg - 53kg	84.24 x 50 x 66	\$10,760
RNS0385A—Nugget head & Bin	Bin storage 40kg	136kg - 112kg	100.4 x 73.81 x 69	\$11,950
RNS0308A—Tubular Nugget Head ONLY		143kg - 114kg	76.2 w	\$10,080
Matching bin sold separately (A320 or A420)				
90% ice to water ratio with longer tubular nugget dispenses chewable ice without congealing—perfect for beverage applications				
RNS0608A—Tubular Nugget Head ONLY		266kg - 204kg	76.2w	\$12,590
RNS1008A—Tubular nugget head ONLY		474kg - 374kg	69.6 x 76 x 60	\$19,380

We recommend that qualified technicians install these machines



1300 673 673



Manitowoc M Series

The Manitowoc M Series—simple with three controls—on, off and clean



Model	21 Air / 10 Water	32 Air / 32 Water	Dimensions W x D x H cm	RRP inc GST
M420	176kg	132kg	55.9 x 62.2 x 54.6	\$5930
M500	214kg	169kg	76.2 x 62.2 x 54.6	\$6380
Bin to suit : A400 or A570				
M700	290kg	228kg	76.2 x 62.2 x 54.6	\$7390
Bin to suit : A400 or A570				
M1000	437kg	374kg	76.2 x 62.2 x 74.9	\$10,090
Bin to suit : A570 or A970 with adapter K00458				
M1400	645kg	479kg	121.9 x 62.2 x 74.9	\$13,700
Bin to suit : A970				



M Series are available in three convenient sizes 22" (55.9cm), 30" (76.2cm) and 48" (121.9cm) with 6 different production ranges from 420 lbs (176 kg) to 1400 lbs (649 kg) of ice

M series ice machines are designed from the ground up to meet your operational demands for a worry-free, simple-to-use, basic ice machine; but that doesn't mean corners were cut on quality.

There are only three controls you need: On, Off and Clean.

And for cleaning, access to the evaporator and food zone is simple with the removal of just two screws and easy, lift-off door.





Accessories

Indigo Model	Suitable for	RRP excl GST
--------------	--------------	--------------

Luminice 11 Growth inhibitor kit—K00450	i-322—i-1106	1,030
Luminice 11 Growth inhibitor kit—K00451	I-1406—i-1800	1,030
Lunimice 11 Growth Inhibitor kit—K00452	Neo U-140—U310	1,030

Filters	Suitable for	RRP excl GST
---------	--------------	--------------

BR10—Suit QM45, Sotto and Neo Model Indigo models	i-322—i-1106	210
BR20—Suit Indigo Models I-906—S3070	I-906—S3070	270
BR30 : Suit poor water areas		440

Adapter Plates	Suitable for	RRP excl GST
----------------	--------------	--------------

K00472	i-322 / i-522 to A400 / A570 bin	470
K00470	i-450 / i-1200 to A970 bin	790

Accessories	Suitable for	RRP excl GST
-------------	--------------	--------------

K00063—Castor kit for NEO machines	NEO Ice machines	640
K00461—External Ice Scoop Holder	All ice bins	273
14199—Ice Scoop with hand Guard	All ice bins	72





Castor Kits & Ice Baggers

Caster Kit	Suitable for	RRP excl GST
K00138	A400 / A570bin	720
K00063	Neo Ice Machines	370



Ice Bagger Assembly	Order Code	RRP excl GST
Ice Bagger	K00146	\$840

Manitowoc Commercial Warranty

Model	Parts	Labour
Sotto	2yr	1yr
Neo	5yr evaporators 5 year compressor	5 year evaporators 3 year compressor
Indigo	5yr evaporators 5 year compressor	5 year evaporators 3 year compressor
QM	3yr	3yr



Preserve Working Capital with Orford Finance

Phone 1300 673 673

Do you have an ABN?
Contact us for a trade discount!

YOURS TODAY:
EB20R-Sn-A



Weekly payments from
\$35

- ✓ Extensive lender panel
- ✓ Conserve working capital
- ✓ 24 hour approvals
- ✓ No financials required

Call Jessica on 1300 736 780 for more details.



YOURS TODAY:
EB36R-Sn



Weekly payments from
\$36

- ✓ Extensive lender panel
- ✓ Conserve working capital
- ✓ 24 hour approvals
- ✓ No financials required

Call Jessica on 1300 736 780 for more details.



YOURS TODAY:
EB45R-Sn



Weekly payments from
\$45

- ✓ Extensive lender panel
- ✓ Conserve working capital
- ✓ 24 hour approvals
- ✓ No financials required

Call Jessica on 1300 736 780 for more details.



YOURS TODAY:
FMB20-Sn



Weekly payments from
\$25

- ✓ Extensive lender panel
- ✓ Conserve working capital
- ✓ 24 hour approvals
- ✓ No financials required

Call Jessica on 1300 736 780 for more details.



YOURS TODAY:
FMB30



Weekly payments from
\$30

- ✓ Extensive lender panel
- ✓ Conserve working capital
- ✓ 24 hour approvals
- ✓ No financials required

Call Jessica on 1300 736 780 for more details.



Promote your Brand — Phone 1300 673 673



Decal Sets RRP — \$240 + GST

Orford can arrange for your artwork to be printed
2 long decals (side) + 2 short (front) decals



Gravity Feed Systems RRP - \$250 + GST per door

Sold as a Per Door kit

Slip mat + 90mm shelf front + fast fit dividers

4 shelf / 35 dividers (enough for 1 door)

- Easy to adjust as planograms change
- Increase the product visibility
- Ticket stripping included

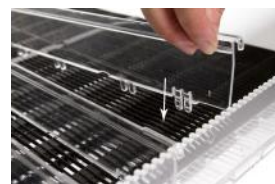

Do you have an ABN?
Contact us for a trade discount!



Roderick Abif 1 Pty Ltd (ABN 72 150 865 008) Trading as Orford Food Services

1. TITLE

Risk in any goods supplied by the seller to the buyer shall pass when such goods are delivered to the buyer or into custody on the buyer's behalf but the ownership of any goods supplied by the seller to the buyer shall remain with the seller until payment in full is made for the goods.

2. WARRANTIES AND REPRESENTATIONS

All new goods supplied are warranted to be free from defects in material and workmanship for a period of 12 months from time of invoice.

The seller is not liable for any injury, loss or damage, directly or consequential, arising out of the use of or the inability to use the goods

Before using, the buyer shall determine suitability of the goods for the buyer's intended use and assume all risk and liability

3. ACCEPTANCE

An offer or quotation by the seller shall become binding upon the seller upon written or verbal acceptance of the quote or of the goods discussed verbally. Acceptance of the goods is deemed to be acceptance of these terms and conditions

4. REJECTION

Except for defective goods supplied by the seller, goods cannot be rejected. Goods damaged during transit on the buyer's own transport are not covered by Orford Foods Services insurance.

5. MANUFACTURERS SPECIFICATION

Due to continuous improvement processes, product specifications may change without notice from time to time

All pricing shown in Orford catalogues are exclusive of GST, freight and insurance

Warranty

This warranty applies for calls of a breakdown service nature only, for problems of manufacturing origin. Recalls, customer related problems (power supply fluctuations, thermostat adjustments, overstocking and over loading of shelves / baskets, choked condenser etc) and any other non warranty nature calls will be charged to the service call originator at normal full rates, payable at the time of the service call.

This warranty is voided, if the equipment has not been properly maintained in accordance with the manufacturer's instructions supplied with the equipment, or the equipment has been subject to power supply fluctuations, misused or transported in a manner which could prejudice the correct operation of the appliance.

Orford does not reimburse or pay for costs relating to travel time, callout or attendance fees, overtime / penalty or premium labour rates or any other costs incurred or charged.

Excluded from Orford warranty are all consumable items such as glass, gaskets, lights, elements, locks, keys, accessories, decals

All warranty work must be authorised in advance by contacting the Customer Service Department on

⇒ Phone 1300 673 673

⇒ Email : mail@orford.com.au



Do you have an ABN?
Contact us for a trade discount!



Do you have an ABN?
Contact us for a trade discount!

CABINET CLASS is a combination of Climate Class and Temperature Class as per the requirements of Australian Standard AS1731

e.g.:- 3L1, 4L2, 5L3 etc.

CLIMATE CLASS defines the climatic ambient conditions for which the cabinet is suited.

Refer table below.

Climate Class	Ambient Temperature	Ambient Humidity
	°C	% RH.
3	25	60
4	30	55
5	40	40
6	27	70
7	35	75

TEMPERATURE CLASS defines the temperature at which the appliance is capable of maintaining product, at a particular Climate Class as per the requirements of Australian Standard AS1731.

Refer examples below:

L1

At the above climate class product temperatures can be maintained between -15°C and -18°C.

As per Australian Standard AS1731.5: 2003 and AS1731.6: 2003. 5 Table 1.

L2

At the above climate class product temperatures can be maintained between -12°C and -18°C.

As per Australian Standard AS1731.5: 2003 and AS1731.6: 2003. 5 Table 1.

L3

At the above climate class product temperatures can be maintained between -12°C and -15°C.

As per Australian Standard AS1731.5: 2003 and AS1731.6: 2003. 5 Table 1.





Minimum Energy Performance Standard (MEPS) Why it Matters



www.orford.com.au

Do you have an ABN?
Contact us for a trade discount!

What are the Consequences if products do NOT comply

The regulator can

- ⇒ Suspend a model's registration
- ⇒ Cancel a models registration
- ⇒ Enforceable undertakings
- ⇒ Infringement notices
- ⇒ Civil penalty orders
- ⇒ Injunctions

The regulator can publicise details relating to enforcement responses including the names of registrants and the model numbers of the products

Protect Yourself

Check that the cabinet is registered for MEPS / GEMS

- ⇒ refer to the MEPS website reg.energyrating.gov.au/comparator/product_types
- ⇒ Research the cabinets MEPS figures on the MEPS website. If for example the MEPS figure is 5.8 (kWh/24hr/m²), this means the amount of total energy consumption over a 24 hour period per square metre of display area
- ⇒ If you cant find the cabinet on the MEPS site, assume it is NOT registered and therefore not legally able to be sold or used in Australia and / or New Zealand



Do you have an ABN?
Contact us for a trade discount!

Which cabinets are covered by the compulsory MEPS / GEMS legislation

- Open Face
- Reach in cabinets
- Food & Deli display cabinets
- Bar Fridges
- Glass door Merchandisers



What are MEPS Ratings?

Reference [Http://www.orford.com.au/orford-eb-energy-figures.html](http://www.orford.com.au/orford-eb-energy-figures.html)

M1

At the above climate class product temperatures can be maintained between -1°C and +5°C.
As per Australian Standard AS1731.5: 2003 and AS1731.6: 2003. 5

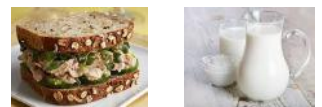

M2

At the above climate class product temperatures can be maintained between -1°C and +7°C.
As per Australian Standard AS1731.5: 2003 and AS1731.6: 2003. 5





Do you have an ABN?
Contact us for a trade discount!

Orford Refrigeration

ABN 72 150 865 008

Head Office

382 South St, Harristown, Qld 4350

National sales :

1300 ORFORD (1300 673 673)

Corby Orford : 0418 700006

Victorian / Tasmanian Sales :

04 ORFORD 74 / 04 673 673 74

Phone : +61 7 46 345 278

Fax : +61 7 46 417 372

Key Websites :

www.orford.com.au

www.flowerfridges4u.com.au

www.orfordspareparts.com.au

All images are subject to copyright and cannot be reproduced without permission

Postal & Business Address

382 South St, Harristown,

Qld 4350

Jeff Ash : 0400 013 958

Email : jeffash@theorfordgroup.com.au

Email : sales@orford.com.au

Email : michael@orford.com.au

Michael Evans : 04 ORFORD 74 (04 673 673 74)

www.orford.com.au

www.facebook.com/theorfordgroup

Key Patents:

AUS DSN no 345317

Patent No 2013100761

“Orford” is protected by Trademark No 1452870

All efforts are made to ensure the accuracy of information, but from time to time errors may occur. Please check prior to placing orders. This publication serves as a guide to the Orford and partner products. Readers are encouraged to contact Orford prior to making final purchasing decisions

